

# SMART HJC 50B

2<sup>nd</sup> GEN PREMIUM MOTORCYCLE BLUETOOTH®  
COMMUNICATION SYSTEM FOR HJC HELMETS

**HD** SPEAKERS

## USER'S GUIDE

# TABLE OF CONTENTS

<b>1.</b>	<b>ABOUT THE SMART HJC 50B</b>	<b>7</b>
<hr/>		
1.1	Product Features	7
1.2	Product Details	8
1.3	Package Contents	9
<b>2.</b>	<b>INSTALLING THE HEADSET ON YOUR HELMET</b>	<b>10</b>
<hr/>		
2.1	Helmet Installation	10
2.1.1	Modular Chin Bar / Open & Full Face Visor Opening	10
2.1.2	Helmet Module Cover Removing	10
2.1.3	Helmet's Cheek Pad Take Off	11
2.1.4	Button Module Installation	11
2.1.5	Bluetooth Module Installation	12
2.1.6	Microphone Installation	13
2.1.7	Speaker Module Installation	16
2.1.8	Wire Arrangement	17
2.1.9	Cheek Pad Fasten Up	17
2.1.10	Modular Chin Bar / Open & Full Face Visor Closing	18
<b>3.</b>	<b>GETTING STARTED</b>	<b>19</b>
<hr/>		
3.1	Downloadable Software	19
3.1.1	SMART HJC BT App	19
3.1.2	SMART HJC Device Manager	19
3.2	Charging	19
3.3	Legend	20
3.4	Powering On and Off	20
3.5	Checking the Battery Level	20
3.6	Volume Adjustment	21

<b>4.</b>	<b>PAIRING THE HEADSET WITH OTHER BLUETOOTH DEVICES</b>	<b>22</b>
<hr/>		
<b>4.1</b>	<b>Phone Pairing</b>	<b>22</b>
4.1.1	Initially Pairing the SMART HJC 50B	22
4.1.2	Pairing When the SMART HJC 50B is Turned Off	23
4.1.3	Pairing When the SMART HJC 50B is Turned On	24
<b>4.2</b>	<b>Second Mobile Phone Pairing - Second Mobile Phone, GPS, and SR10</b>	<b>24</b>
<b>4.3</b>	<b>Advanced Selective Pairing: Hands-Free or A2DP Stereo</b>	<b>25</b>
4.3.1	Phone Selective Pairing - Hands-Free Profile	25
4.3.2	Media Selective Pairing - A2DP Profile	25
<b>4.4</b>	<b>GPS Pairing</b>	<b>26</b>
<b>5.</b>	<b>MOBILE PHONE USAGE</b>	<b>27</b>
<hr/>		
<b>5.1</b>	<b>Making and Answering Calls</b>	<b>27</b>
<b>5.2</b>	<b>Siri and Google Assistant</b>	<b>27</b>
<b>5.3</b>	<b>Speed Dialing</b>	<b>27</b>
5.3.1	Assigning Speed Dial Presets	27
5.3.2	Using Speed Dial Presets	28
<b>6.</b>	<b>STEREO MUSIC</b>	<b>29</b>
<hr/>		
<b>6.1</b>	<b>Bluetooth Stereo Music</b>	<b>29</b>
<b>6.2</b>	<b>Music Sharing</b>	<b>29</b>
6.2.1	Bluetooth Intercom Music Sharing	30
6.2.2	Mesh Intercom Music Sharing	30
<b>7.</b>	<b>MESH INTERCOM</b>	<b>31</b>
<hr/>		
<b>7.1</b>	<b>What is Mesh Intercom?</b>	<b>31</b>
7.1.1	Open Mesh	32
7.1.2	Group Mesh	32

<b>7.2</b>	<b>Starting Mesh Intercom</b>	<b>33</b>
<b>7.3</b>	<b>Using the Mesh in Open Mesh</b>	<b>33</b>
7.3.1	Channel Setting (Default: channel 1)	33
<b>7.4</b>	<b>Using Mesh in Group Mesh</b>	<b>34</b>
7.4.1	Creating a Group Mesh	34
7.4.2	Joining an Existing Group Mesh	35
<b>7.5</b>	<b>Enable/Disable Mic (Default: Enable)</b>	<b>36</b>
<b>7.6</b>	<b>Toggling Open Mesh/Group Mesh</b>	<b>36</b>
<b>7.7</b>	<b>Reset Mesh</b>	<b>36</b>
<b>8.</b>	<b>BLUETOOTH INTERCOM</b>	<b>37</b>
<hr/>		
<b>8.1</b>	<b>Intercom Pairing</b>	<b>37</b>
8.1.1	Using the Smart Intercom Pairing (SIP)	37
8.1.2	Using the Button	38
<b>8.2</b>	<b>Last-Come, First-Served</b>	<b>39</b>
<b>8.3</b>	<b>Two-Way Intercom</b>	<b>40</b>
<b>8.4</b>	<b>Multi-Way Intercom</b>	<b>41</b>
8.4.1	Starting a Three-Way Intercom Conference	41
8.4.2	Starting a Four-Way Intercom Conference	42
8.4.3	Ending Multi-Way Intercom	42
<b>8.5</b>	<b>Three-Way Conference Phone Call with Intercom Users</b>	<b>43</b>
<b>8.6</b>	<b>Group Intercom</b>	<b>44</b>
<b>8.7</b>	<b>Mesh Intercom Conference with Bluetooth Intercom Participant</b>	<b>44</b>
<b>9.</b>	<b>UNIVERSAL INTERCOM</b>	<b>46</b>
<hr/>		
<b>9.1</b>	<b>Universal Intercom Pairing</b>	<b>46</b>
<b>9.2</b>	<b>Two-Way Universal Intercom</b>	<b>46</b>

<b>9.3</b>	<b>Multi-Way Universal Intercom</b>	<b>47</b>
9.3.1	Three-Way Universal Intercom	47
9.3.2	Four-Way Universal Intercom	48
<b>9.4</b>	<b>Mesh Intercom Conference with Two-way Universal Intercom Participant</b>	<b>49</b>
<b>10.</b>	<b>USING THE FM RADIO</b>	<b>50</b>
<b>10.1</b>	<b>FM Radio On/Off</b>	<b>50</b>
<b>10.2</b>	<b>Seek and Save Radio Stations</b>	<b>50</b>
<b>10.3</b>	<b>Scan and Save Radio Stations</b>	<b>51</b>
<b>10.4</b>	<b>Temporary Station Preset</b>	<b>51</b>
<b>10.5</b>	<b>Navigating Preset Stations</b>	<b>52</b>
<b>11.</b>	<b>VOICE COMMAND</b>	<b>53</b>
<b>12.</b>	<b>FUNCTION PRIORITY AND FIRMWARE UPGRADES</b>	<b>55</b>
<b>12.1</b>	<b>Function Priority</b>	<b>55</b>
<b>12.2</b>	<b>Firmware Upgrades</b>	<b>55</b>
<b>13.</b>	<b>CONFIGURATION SETTING</b>	<b>56</b>
<b>13.1</b>	<b>Headset Configuration Menu</b>	<b>56</b>
13.1.1	Delete All Pairings	57
13.1.2	Remote Control Pairing	57
<b>13.2</b>	<b>Software Configuration Setting</b>	<b>57</b>
13.2.1	Headset Language	57
13.2.2	Audio Equalizer (Default: Off)	58
13.2.3	VOX Phone (Default: Enable)	58
13.2.4	VOX Intercom (Default: Disable)	58
13.2.5	VOX Sensitivity (Default: 3)	59

13.2.6	HD Intercom (Default: Enable)	59
13.2.7	HD Voice (Default: Enable)	59
13.2.8	Bluetooth Intercom Audio Multitasking (Default: Disable)	60
13.2.9	Intercom-Audio Overlay Sensitivity (Default: 3)	60
13.2.10	Audio Overlay Volume Management (Default: Disable)	60
13.2.11	Smart Volume Control (Default: Disable)	61
13.2.12	Sidetone (Default: Disable)	61
13.2.13	Voice Prompt (Default: Enable)	61
13.2.14	RDS AF Setting (Default: Disable)	61
13.2.15	FM Station Guide (Default: Enable)	61
13.2.16	Advanced Noise Control™ (Default: Enable)	61
13.2.17	Region Selection	62

## **14. TROUBLESHOOTING** **63**

---

### **14.1 Fault Reset** **63**

### **14.2 Factory Reset** **64**

# 1. ABOUT THE SMART HJC 50B

## 1.1 Product Features



Bluetooth® 5.0



Mesh Intercom™ up to 2 km (1.2 mi)\*



Intercom up to 2 km (1.2 mi)\*



Audio Multitasking™



- Multi-Language Voice Command
- Support Siri and Google Assistant



Custom Helmet Fit

\* in open terrain

## 1.2 Product Details

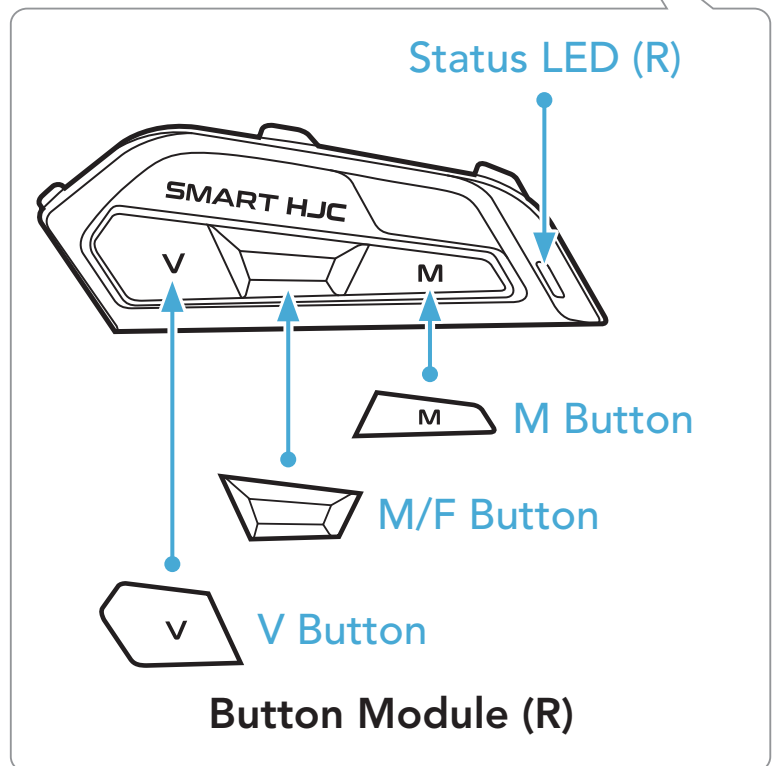
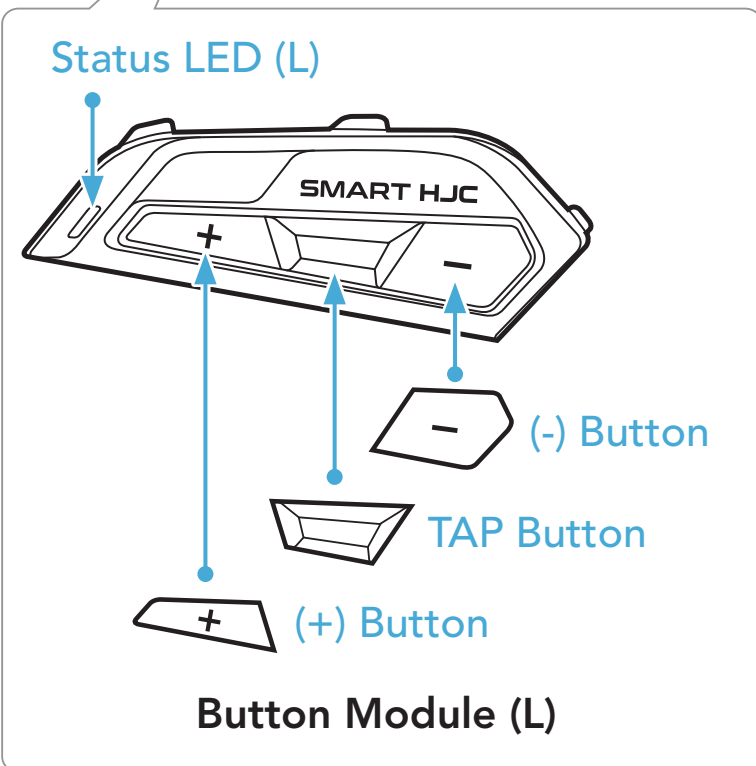
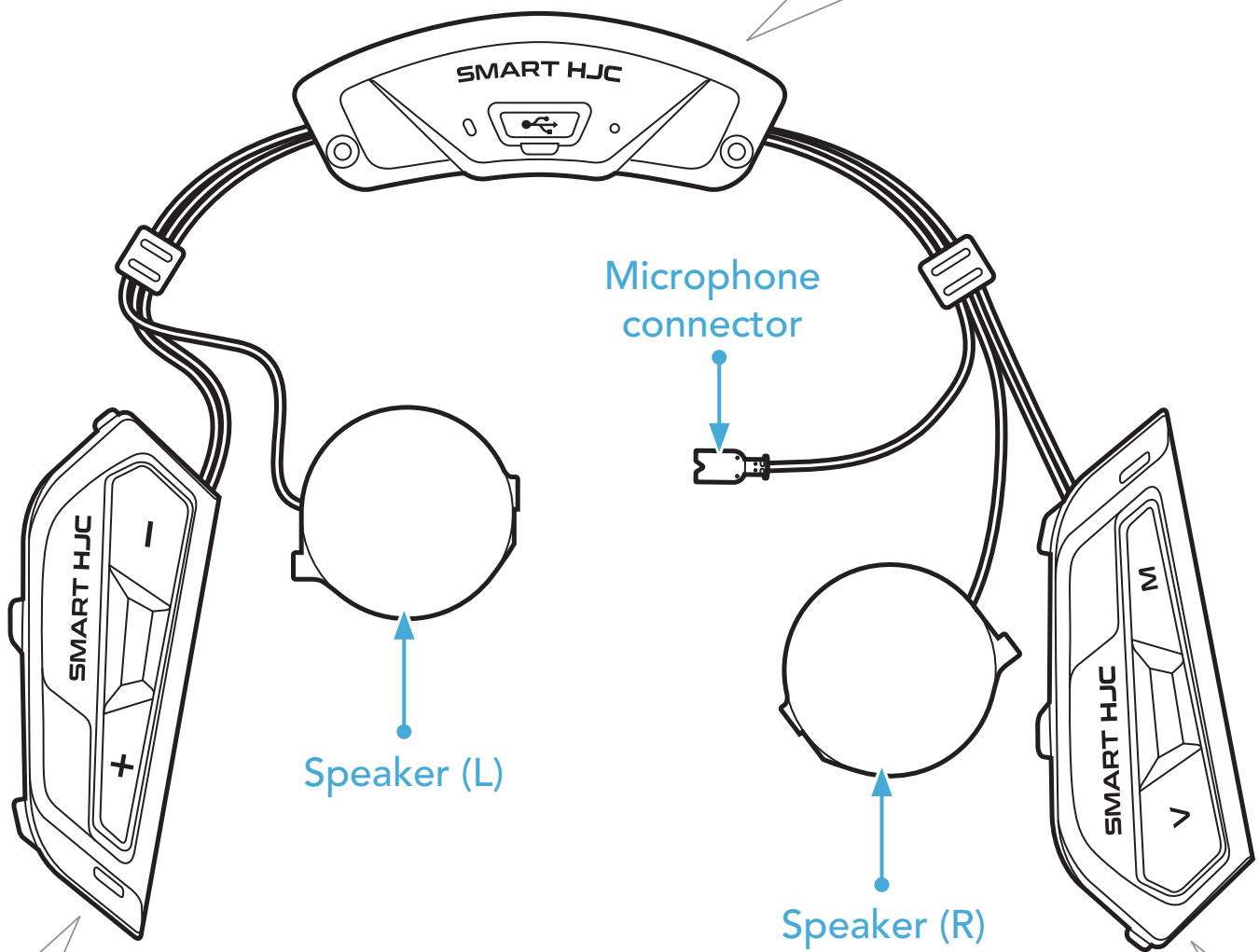
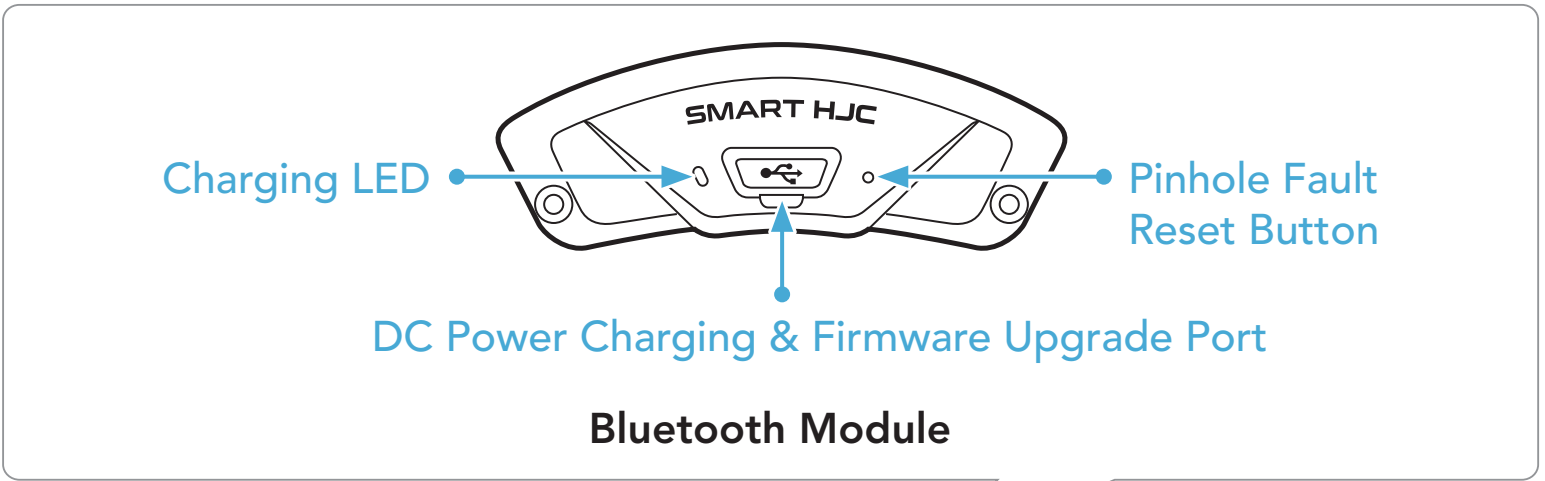

\* Status LED (L) and Status LED (R) operate simultaneously.



## 1.3 Package Contents

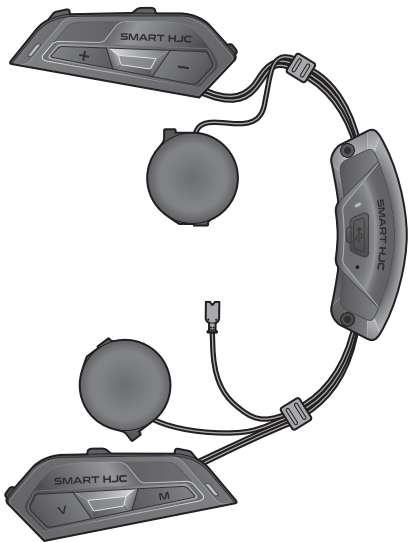

Headset Main Unit

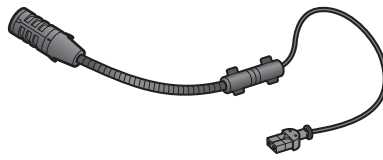

Wired Boom Microphone for Modular/Open Face Helmet

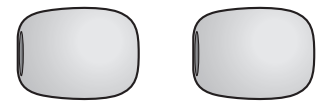

Microphone Sponges for Wired Boom Microphone

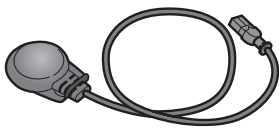

Wired Microphone for Full Face Helmet

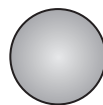

Hook and Loop Fastener for Wired Microphone



Screws

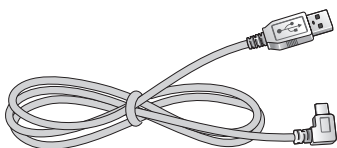

USB Power & Data Cable (USB-C)



Allen Wrench

## 2. INSTALLING THE HEADSET ON YOUR HELMET

SMART HJC 50B compatible **HJC helmets** can be found at [www.smarthjc.com](http://www.smarthjc.com)

### 2.1 Helmet Installation

To securely install the headset on the Modular helmet, Open Face helmet, or Full Face helmet, please follow this procedure.

#### 2.1.1 Modular Chin Bar / Open & Full Face Visor Opening

1. Lift the chin-bar of the modular helmet or the shield visor of the open face helmet completely.

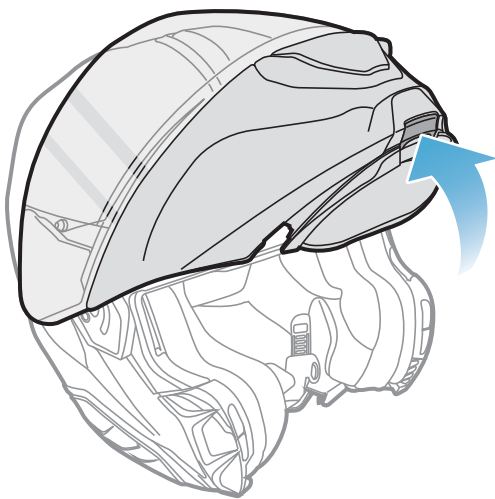

Modular Helmet

or

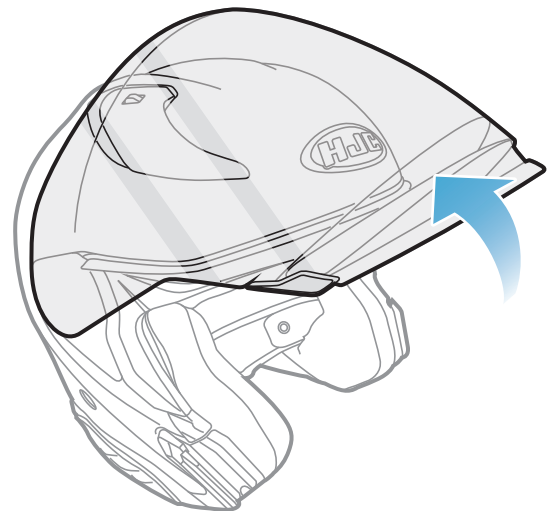

Open Face Helmet

#### 2.1.2 Helmet Module Cover Removing

1. By pushing the tab on the left side cover, push at an angle the left side cover to remove it.

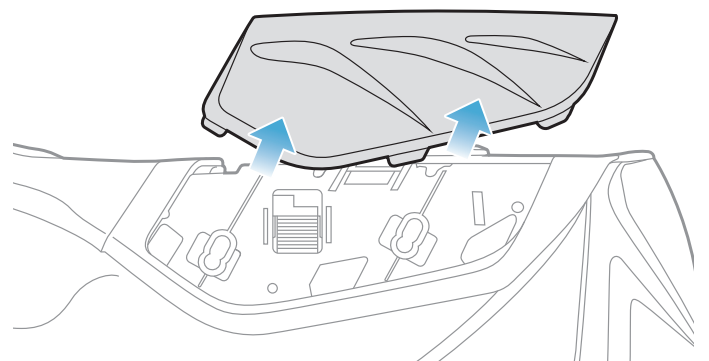
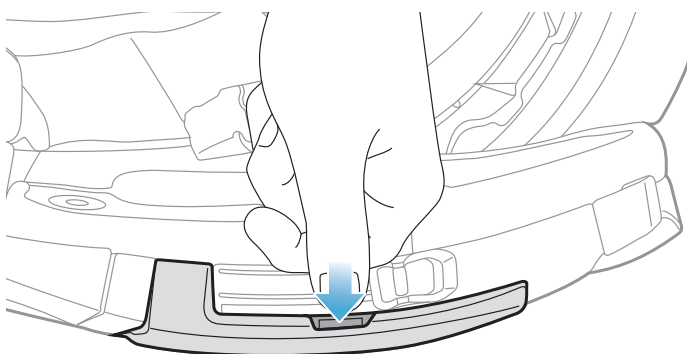

2. Repeat the process on the other side to remove the right side cover.
3. Loosen the two short screws on the rear cover of the helmet with the Allen wrench that comes included, and then remove the cover.

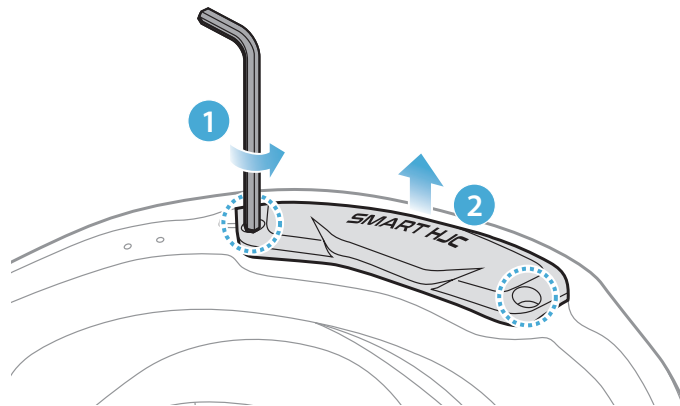

### 2.1.3 Helmet's Cheek Pad Take Off

1. Detach the snap fasteners of the cheek pads and remove the cheek pads from the helmet.

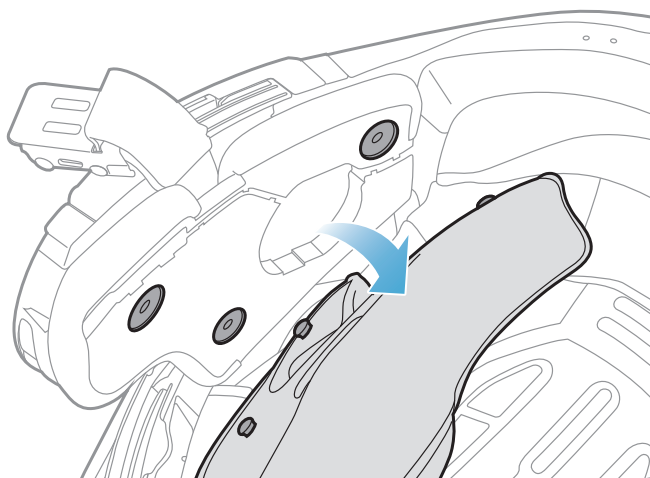

### 2.1.4 Button Module Installation

1. Make sure that the grooved side of the Button Module (L) fits the corresponding grooves. Then, slide the Button Module (L) into the corresponding place until you hear a click sound.

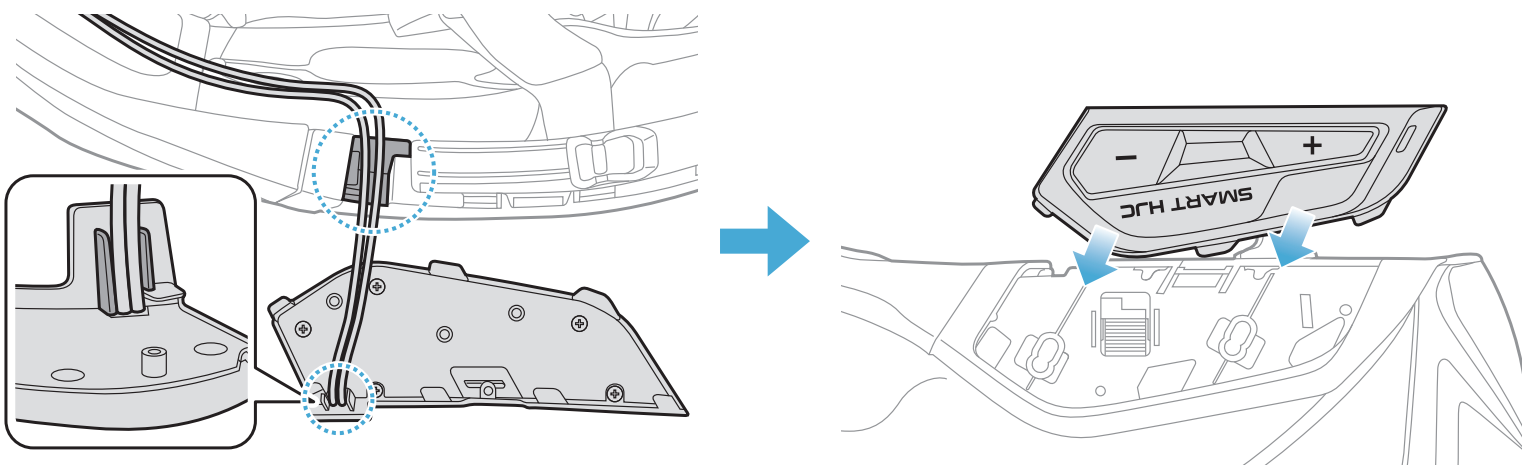

**Note:** Make sure the Button Module's wire is placed in the corresponding groove as shown in the illustration.

2. Repeat the process on the other side to install the Button Module (R).

### 2.1.5 Bluetooth Module Installation

1. Facing the USB port on the Bluetooth Module toward the rear of the helmet, pull the rubber guard up and insert the Bluetooth Module into the slot.

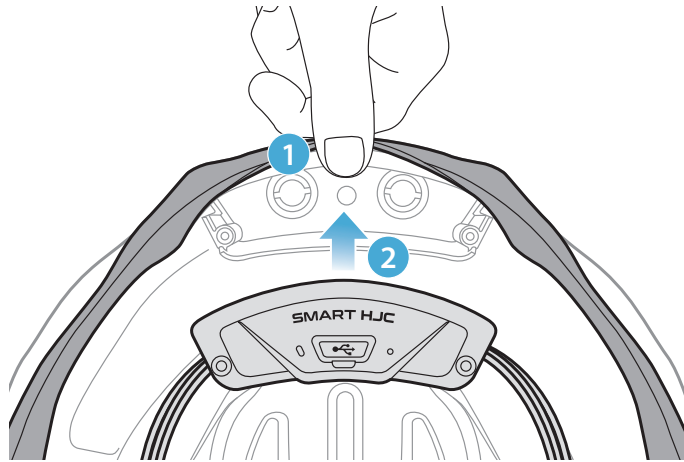

**Note:** Make sure the rubber guard of the helmet is not jammed between the Bluetooth Module and its slot.

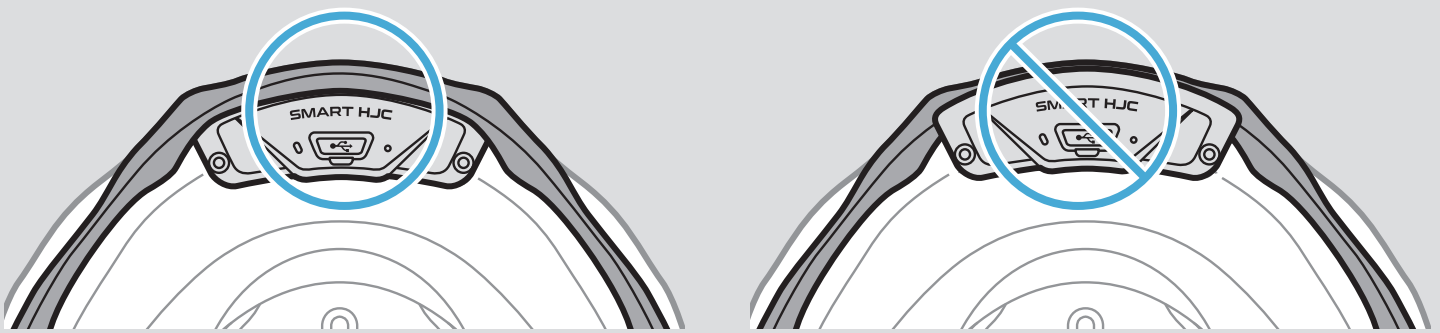

2. To organize the Bluetooth Module's wire, pull back the rubber guard and place the wire in the groove as shown in the illustration.

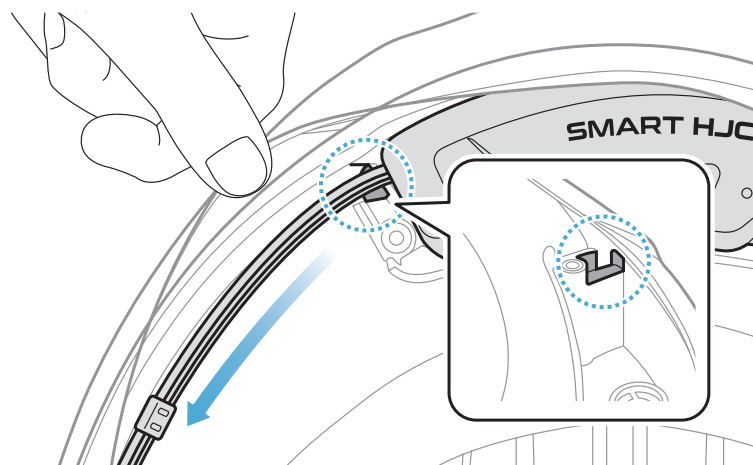

- Put the remaining wire into the gap under the helmet's rubber guard.

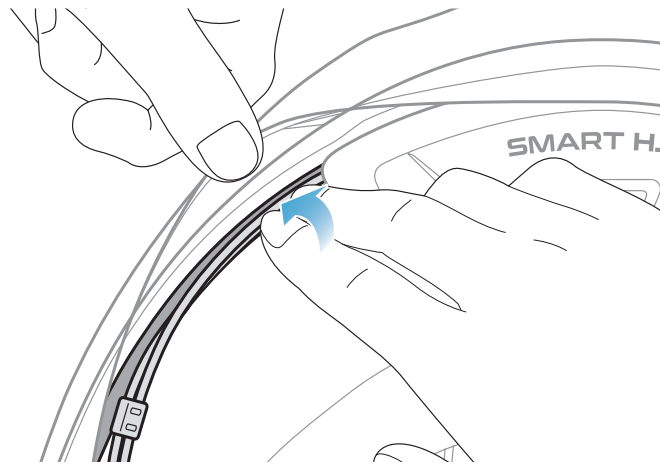

- Tighten the two long screws until the Bluetooth Module is fastened firmly to the helmet.

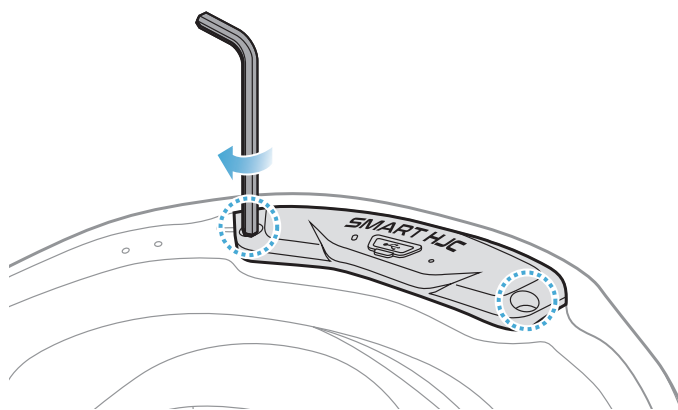

## 2.1.6 Microphone Installation

- Modular or Open Face Microphone Installation

- Insert the Wired Boom Microphone's long hook into the groove in the EPS of the helmet first and then insert the short hook.

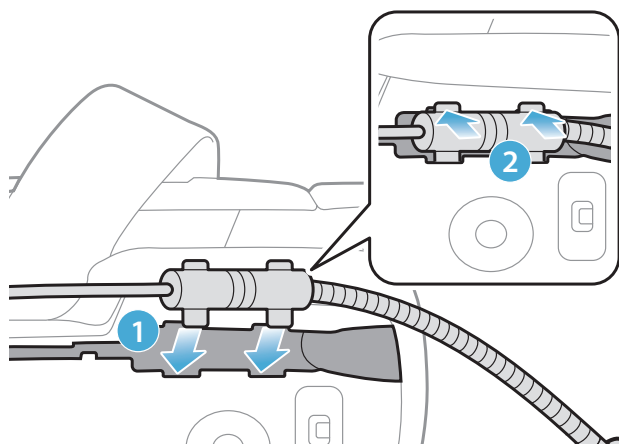

2. Place the microphone's wire in the groove and then place the remaining portion of microphone's wire into the speaker pocket for installing the speaker unit.

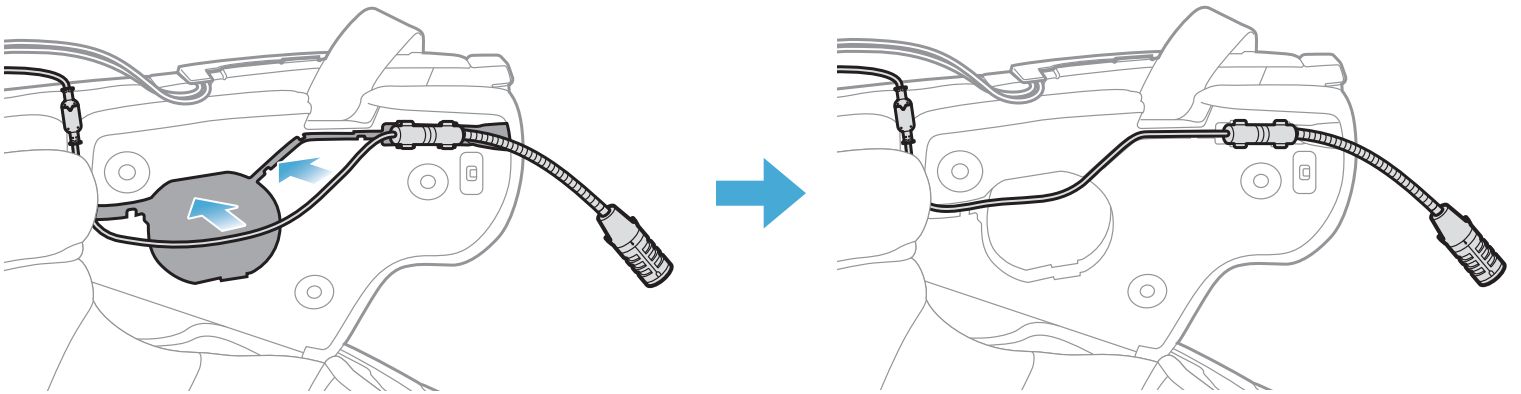

3. Align the arrows on the microphone wire and insert the microphone wire into the microphone connector.

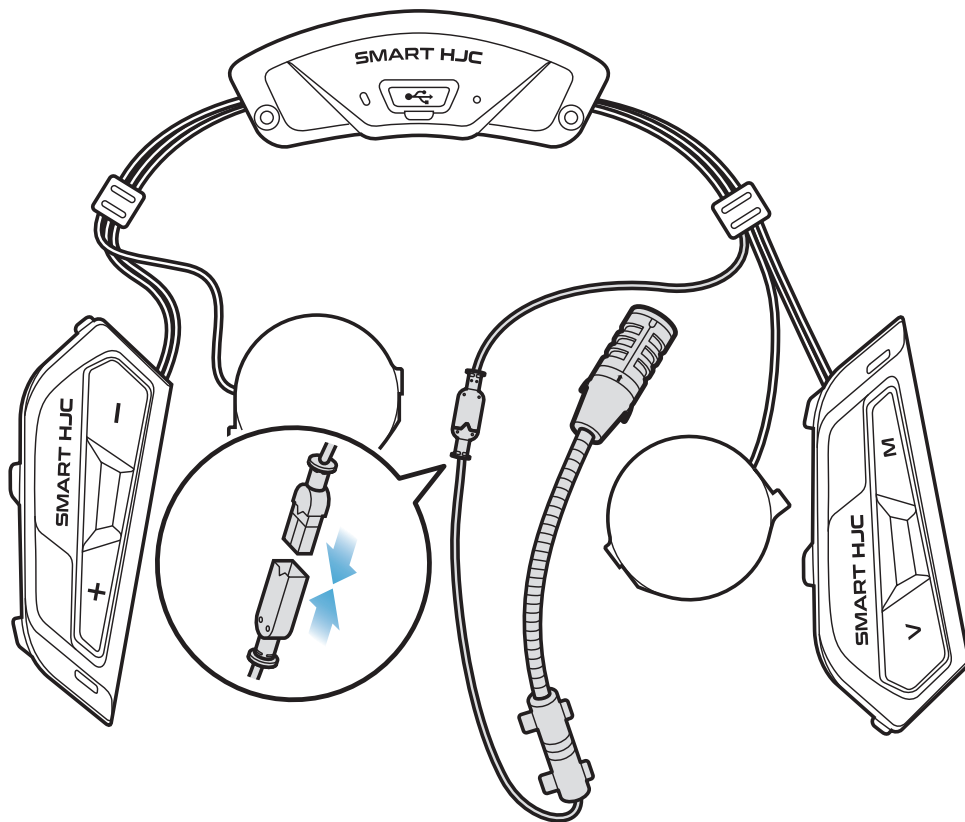

- Full Face Microphone Installation

1. Peel off the cover of the adhesive tape of the hook and loop fastener for the microphone and attach it to the inside of the helmet's chin guard.

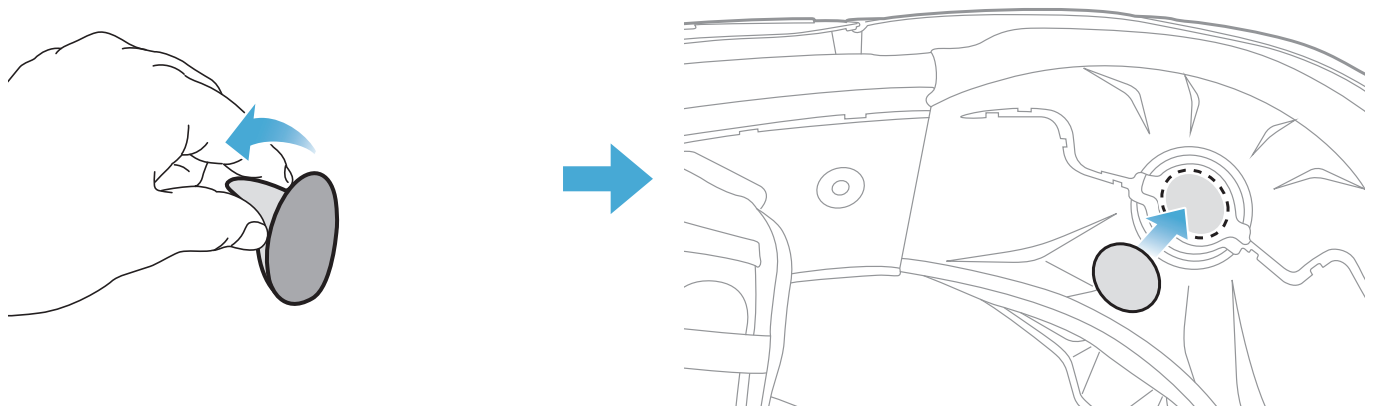

2. Attach the wired microphone to the hook and loop fastener.

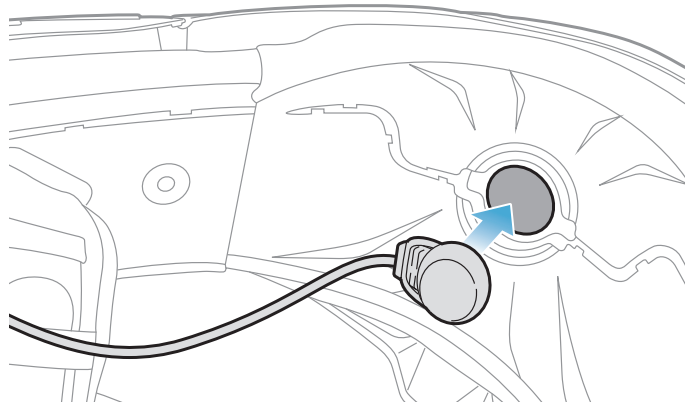

3. Place the microphone's wire in the groove and then place the remaining portion of the microphone's wire in the speaker pocket for installing the speaker unit as shown in the illustration.

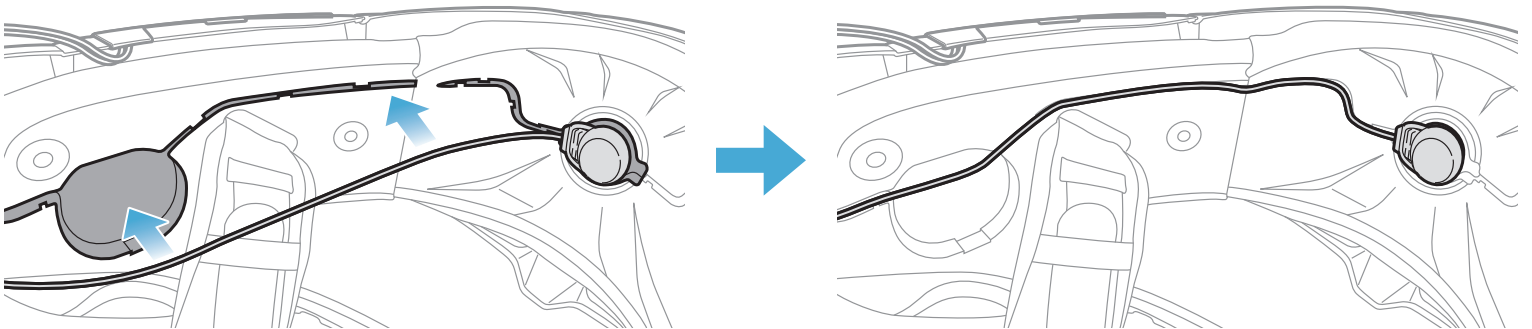

4. Align the arrows on the microphone wire and insert the microphone wire into the microphone connector.

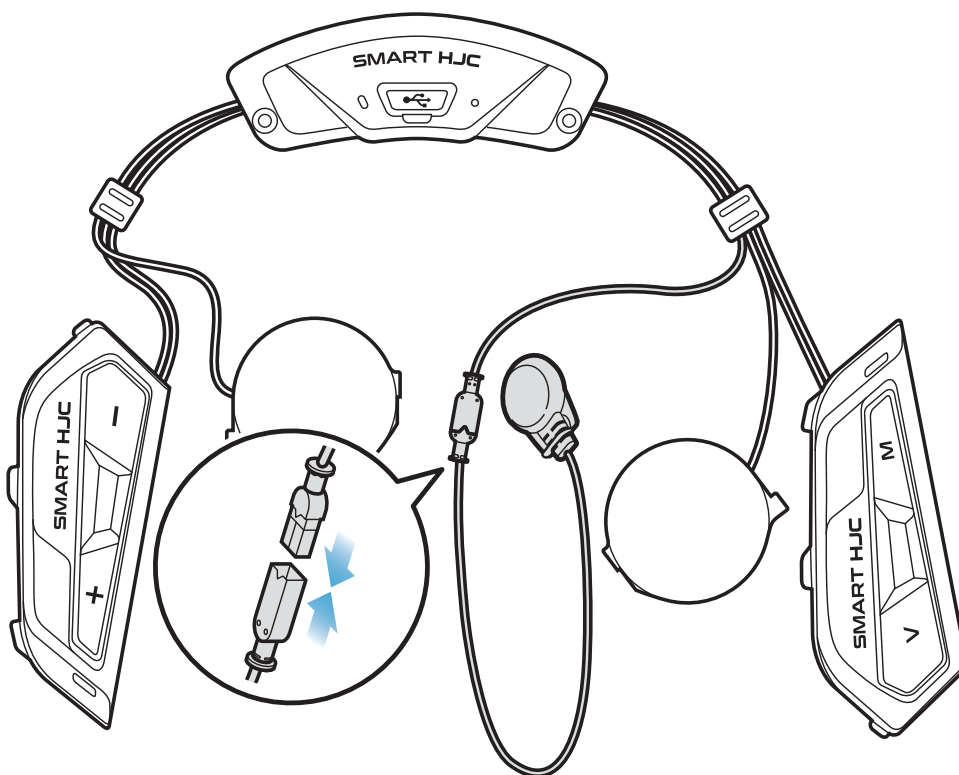

## 2.1.7 Speaker Module Installation

1. Insert the longer hook of the right speaker unit into the bottom hole of the speaker pocket. Then, insert the shorter hook of the right speaker unit into the top hole of the speaker pocket.

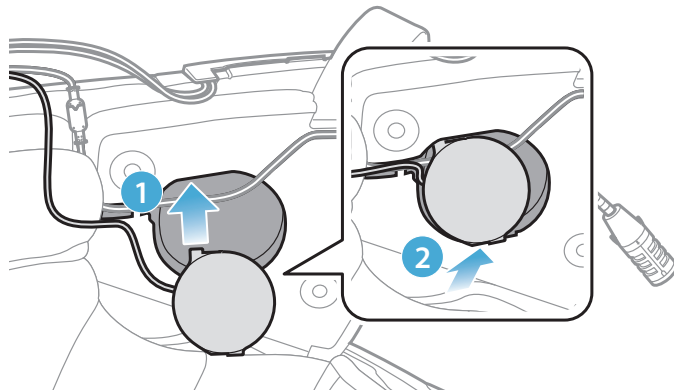

**[Make sure that the Microphone wire is not pressured by the speaker unit when installed]**

2. Then, push the top of the unit so that it fixes onto the helmet's speaker pocket.

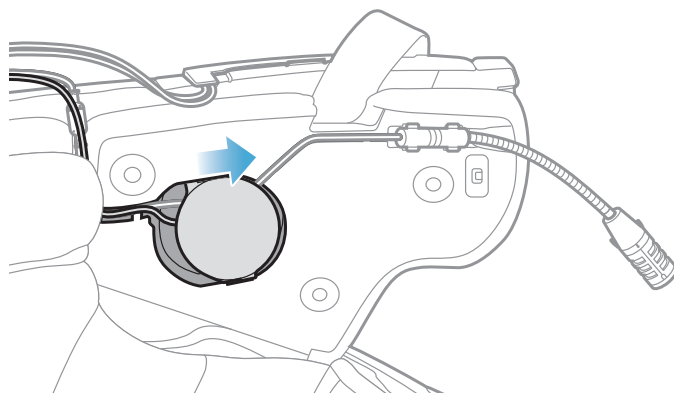

**[Once installed, the position of the speaker unit can be adjusted to rider's ear position]**

3. Repeat the process on the other side to install the left speaker unit.

### **Note:**

#### **Removing the Speaker Unit**

To remove the speaker unit, insert the **Allen Wrench** into the upper shorter hook area then pull out the speaker unit.

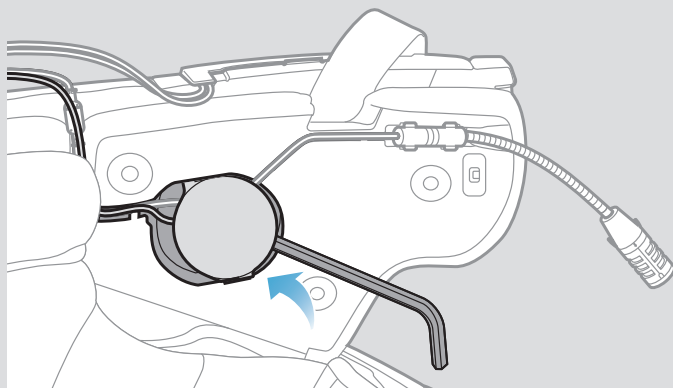



## 2.1.8 Wire Arrangement

1. Put the bundle of the wires in the gap under the helmet's rubber guard and organize the remaining wire in the shape of an arch as shown in the illustration.

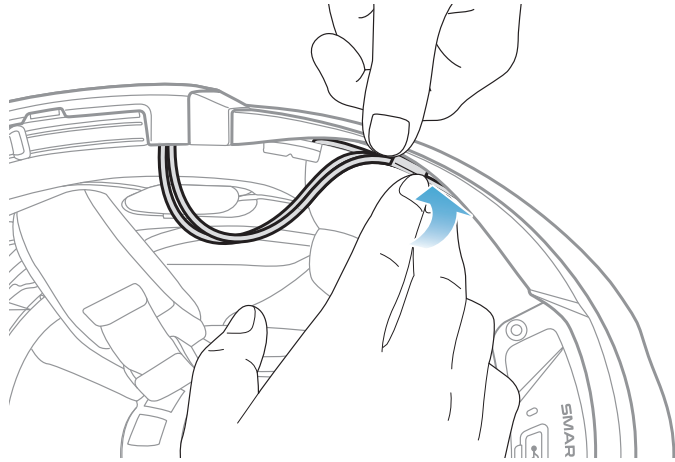

2. Align the remaining wire and groove of the cheek pad, and insert the cheek pad beginning with its rear as shown in the illustration.

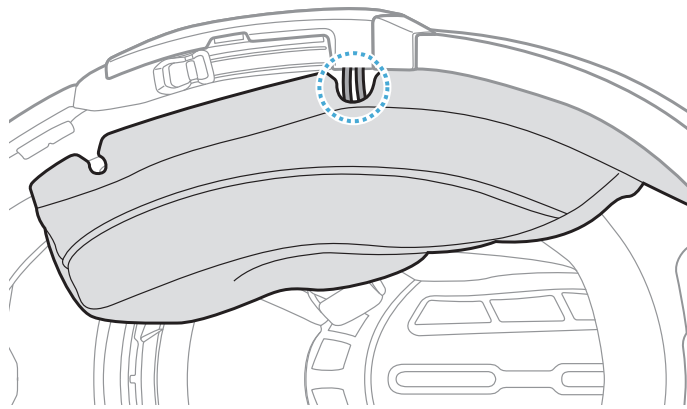

## 2.1.9 Cheek Pad Fasten Up

1. Reattach the cheek pads, beginning with its rear, and click the snap fasteners.

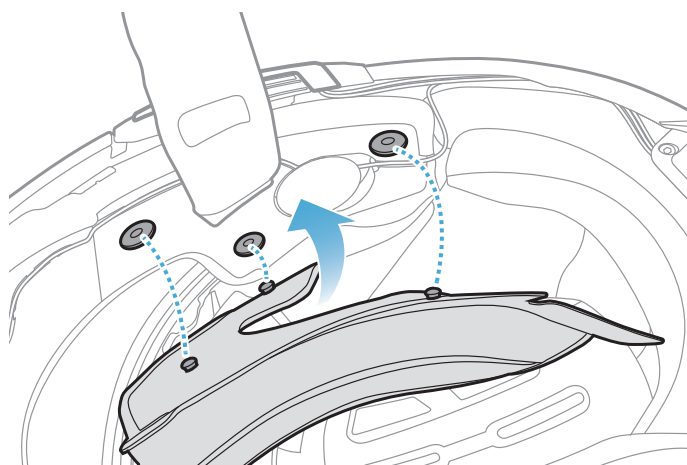

### 2.1.10 Modular Chin Bar / Open & Full Face Visor Closing

1. Lower the chin-bar of the modular helmet or the shield visor of the open face helmet completely.

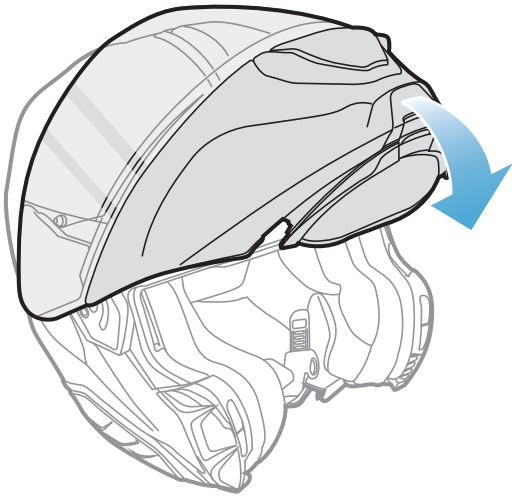

**Modular Helmet**

or

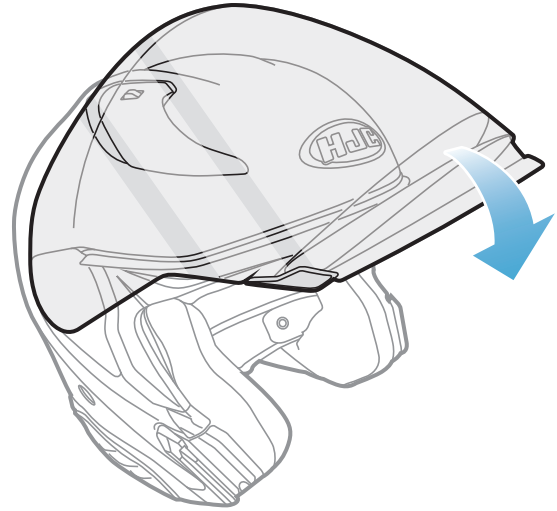

**Open Face Helmet**

2. Make sure that the Wired Boom Microphone is a proper distance from your mouth when you wear the helmet.

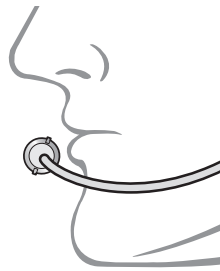

# 3. GETTING STARTED

## 3.1 Downloadable Software

### 3.1.1 SMART HJC BT App

By simply pairing your phone with your headset, you can use the **SMART HJC BT App** for quicker, easier set up and management.



- Download the **SMART HJC BT App** on [Google Play Store](#) or [App Store](#).

### 3.1.2 SMART HJC Device Manager

The **SMART HJC Device Manager** allows you to upgrade firmware and configure settings directly from your PC.



- Download the **SMART HJC Device Manager** at [www.smarthjc.com](http://www.smarthjc.com)

## 3.2 Charging

### Charging the headset

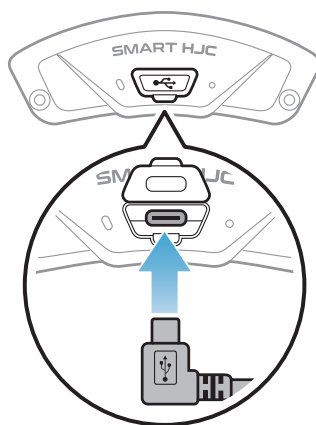
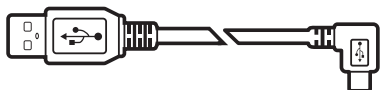

Depending upon the charging method, the headset will be fully charged in about 2.5 hours.

**Note:**

- Please make sure to take off your headset-installed helmet while charging. The headset automatically turns off during charging.
- Any 3rd party USB charger can be used with HJC products if the charger is approved by either the FCC, CE, IC, KC, or other locally approved agencies.
- Use of a non-approved charger may cause fire, explosion, leakage, and other hazards which may also reduce the life time or performance of the battery.
- The **headset** is compatible with 5 V input USB-charged devices only.

### 3.3 Legend



Tap button the specified number of times



Press and Hold button for the specified amount of time



"Hello"

Audible prompt

### 3.4 Powering On and Off

#### Powering On

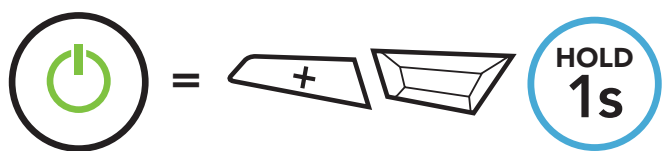

#### Powering Off

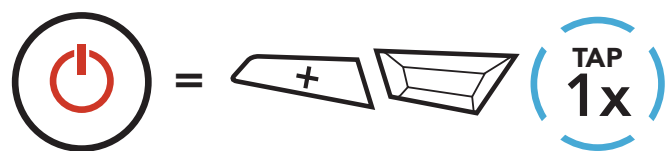

### 3.5 Checking the Battery Level

Instructions are for when powering the headset on.

#### Powering On

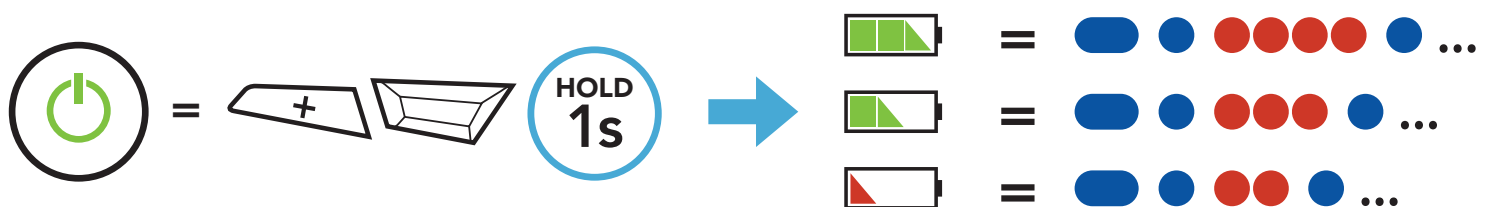

**Note:** When the battery is low while in use, you will hear a voice prompt saying **"Low battery"**.

## 3.6 Volume Adjustment

You can raise or lower the volume by tapping the **(+) Button** or the **(-) Button**. Volume is set and maintained independently at different levels for each audio source (i.e., phone, intercom), even when the headset is rebooted.

### Volume Up

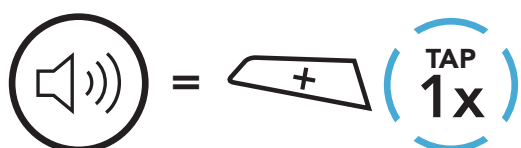

### Volume Down

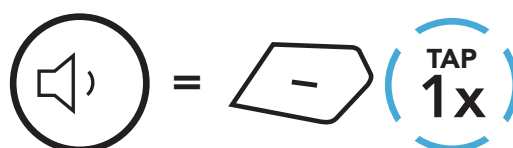

## 4. PAIRING THE HEADSET WITH OTHER BLUETOOTH DEVICES

When using the headset with other Bluetooth devices for the first time, they will need to be “paired.” This enables them to recognize and communicate with one another whenever they are within range.

The headset can pair with multiple Bluetooth devices such as a mobile phone, GPS, MP3 player or Sena SR10 Two-Way Radio Adapter via **Mobile Phone Pairing, Second Mobile Phone Pairing and GPS Pairing**. The headset can also be paired with up to three other SMART HJC headsets.

Pairs with up to Three SMART HJC headsets



Also Pairs with:

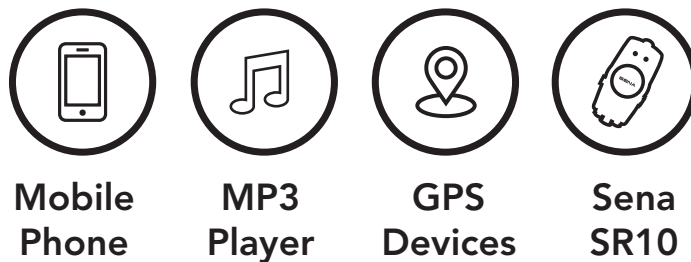

### 4.1 Phone Pairing

There are three ways to pair the phone.

#### 4.1.1 Initially Pairing the SMART HJC 50B

The headset will automatically enter the phone pairing mode when you initially turn on the headset or in the following situation:

- Rebooting after executing **Factory Reset**; or
- Rebooting after executing **Delete All Pairings**.

1. Press and hold the **TAP Button** and the **(+) Button** for **1 second**.



2. Select **SMART HJC 50B** in the list of Bluetooth devices detected. If your mobile phone asks for a PIN, enter 0000.

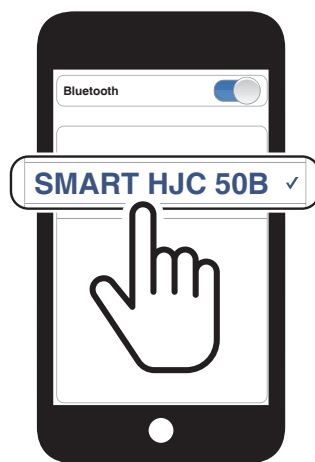

**Note:**

- The phone pairing mode lasts for **3 minutes**.
- To cancel phone pairing, tap the **TAP Button**.

### 4.1.2 Pairing When the SMART HJC 50B is Turned Off

1. While the headset is off, press and hold the **TAP Button** and the **(+) Button** until the LED flashes red and blue alternately and you hear a voice prompt, **"Phone pairing"**.



2. Select **SMART HJC 50B** in the list of Bluetooth devices detected. If your mobile phone asks for a PIN, enter 0000.



### 4.1.3 Pairing When the SMART HJC 50B is Turned On

1. While the headset is on, press and hold the **TAP Button** for **10 seconds**.



2. Tap the **(+) Button**.



3. Select **SMART HJC 50B** in the list of Bluetooth devices detected. If your mobile phone asks for a PIN, enter 0000.

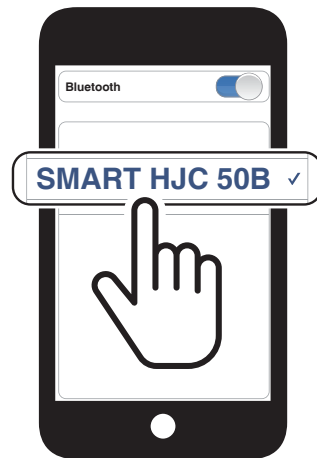

### 4.2 Second Mobile Phone Pairing - Second Mobile Phone, GPS, and SR10

1. Press and hold the **TAP Button** for **10 seconds**.



2. Double tap the **(+) Button**.



3. Select **SMART HJC 50B** in the list of Bluetooth devices detected. If your Bluetooth device asks for a PIN, enter 0000.

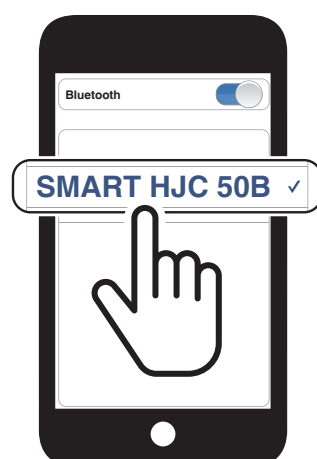



## 4.3 Advanced Selective Pairing: Hands-Free or A2DP Stereo

**Phone Pairing** allows the headset to establish two Bluetooth profiles: **Hands-Free** or **A2DP Stereo**. **Advanced Selective Pairing** allows the headset to separate the profiles to enable connection with two devices.

### 4.3.1 Phone Selective Pairing - Hands-Free Profile

1. Press and hold the **TAP Button** for **10 seconds**.



2. Tap the **(+) Button** **3 times**.

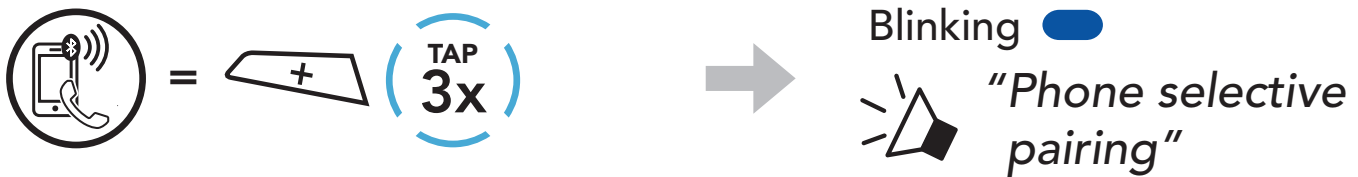

3. Select **SMART HJC 50B** in the list of Bluetooth devices detected. If your mobile phone asks for a PIN, enter 0000.



### 4.3.2 Media Selective Pairing - A2DP Profile

1. Press and hold the **TAP Button** for **10 seconds**.



2. Tap the **(+) Button** **4 times**.

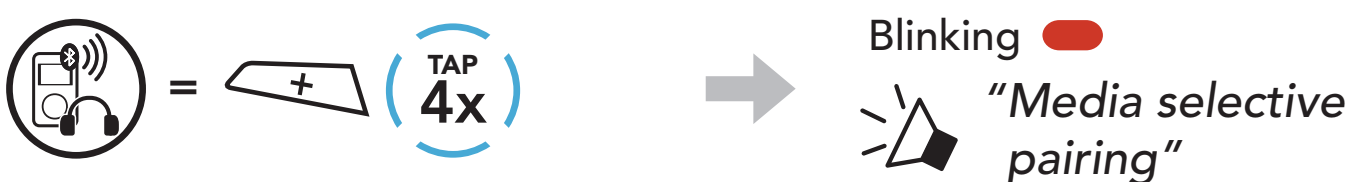

3. Select **SMART HJC 50B** in the list of Bluetooth devices detected. If your mobile phone asks for a PIN, enter 0000.

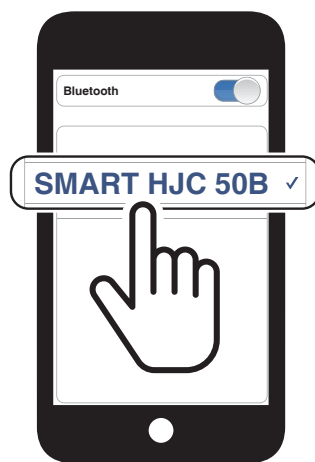

## 4.4 GPS Pairing

1. Press and hold the **TAP Button** for **10 seconds**.



2. Tap the **(+) Button** 5 times.



3. Select **SMART HJC 50B** in the list of devices detected. If your Bluetooth device asks for a PIN, enter 0000.



**Note:** If you pair your GPS device via GPS Pairing, its instruction will not interrupt your Mesh Intercom conversations, but overlay with them. Bluetooth intercom conversations will be interrupted by GPS instructions.

# 5. MOBILE PHONE USAGE

## 5.1 Making and Answering Calls

### Answer a Call

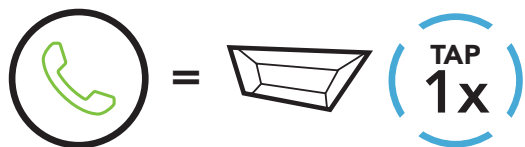

### End a Call

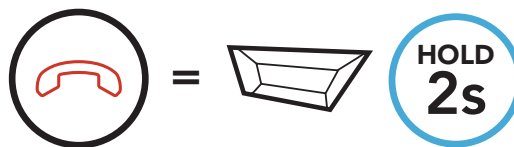

### Reject a Call

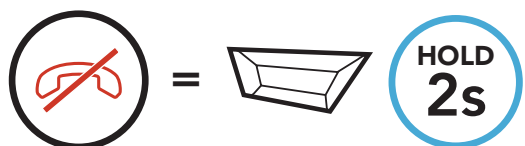

**Note:** If you have a GPS device connected, you will not hear its voice navigations during a phone call.

## 5.2 Siri and Google Assistant

The **SMART HJC 50B** supports the **Siri** and **Google Assistant** access directly.

You can activate the **Siri** or **Google Assistant** using the voice through the SMART HJC 50B's microphone, a wake word will be used. This is a word or groups of words such as **"Hey Siri"** or **"Hey Google"**.

### Activate the Siri or Google Assistant Installed on Your Smartphone

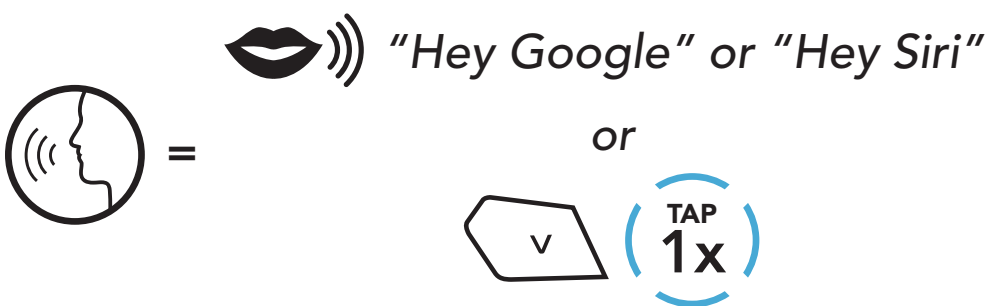

## 5.3 Speed Dialing

### 5.3.1 Assigning Speed Dial Presets

**Speed Dial Presets** could be assigned through the **SMART HJC BT App**.

### 5.3.2 Using Speed Dial Presets

1. Enter into the **Speed Dial** menu.

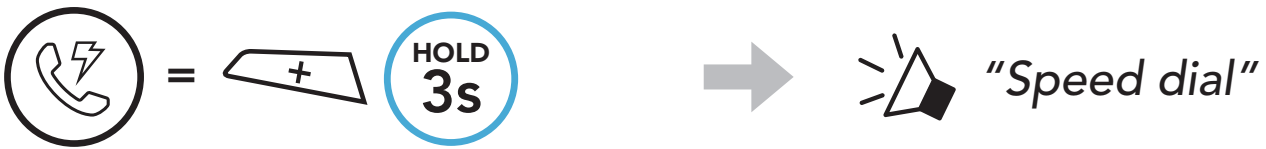

2. Navigate forward or backward through **Speed Dial Preset** numbers.

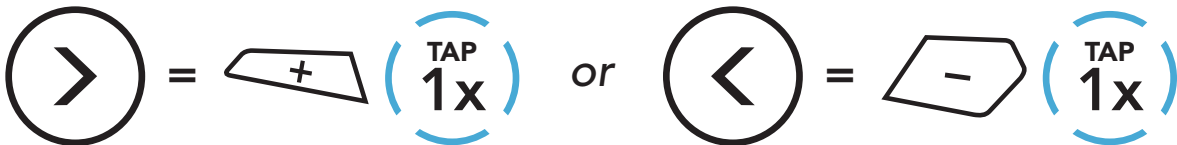

(1) Last number redial

(4) Speed dial 3

(2) Speed dial 1

(5) Cancel

(3) Speed dial 2

3. Call one of your **Speed Dial Presets** numbers.



4. Redial the last number called.

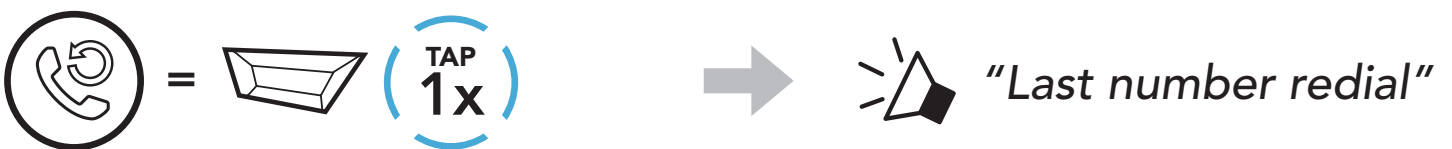

# 6. STEREO MUSIC

## 6.1 Bluetooth Stereo Music

### Play/Pause Music

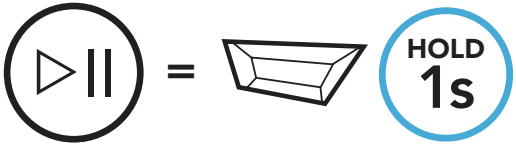

### Next Track

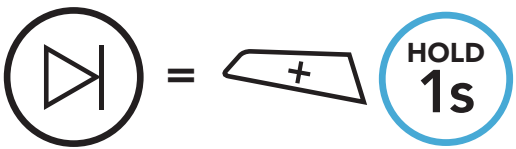

### Previous Track

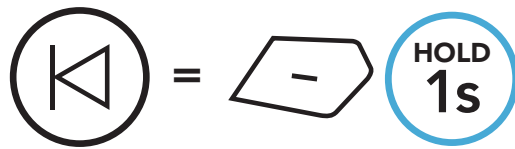

## 6.2 Music Sharing

You can start sharing music with one intercom friend using Bluetooth stereo music during a two-way intercom conversation and one participant of a Mesh. If you start sharing music while Bluetooth intercom and Mesh Intercom are running at the same time, then music shared during Bluetooth intercom will take priority over music shared during Mesh Intercom.

### Note:

- Both you and your intercom friend can remotely control music playback such as track forward and track back.
- **Music sharing** will be paused when you are using your mobile phone or listening to GPS instructions.
- **Music sharing** will be terminated if the headset starts a multi-way intercom conference.

## 6.2.1 Bluetooth Intercom Music Sharing

You can start sharing the music with one intercom friend of a two-way intercom conversation.

### Start/Terminate Sharing Music



## 6.2.2 Mesh Intercom Music Sharing

You can start sharing music with one participant of a **Mesh Intercom**.

### Start Sharing Music

1. The **Creator** will send a request message to **participants** connected during **Mesh Intercom**.

[Creator]

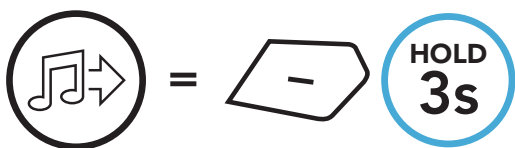

[Creator]



[Participants]

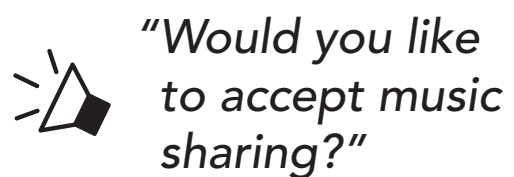

2. The **Creator** will share music with the **first participant** that accepts the request.

[Participant] Accept

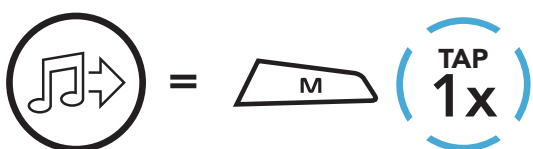

[Participant] Refuse

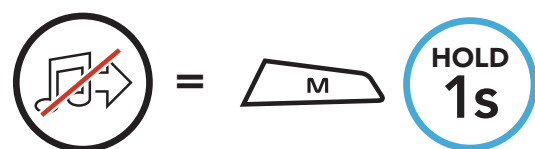

### Terminate Sharing Music

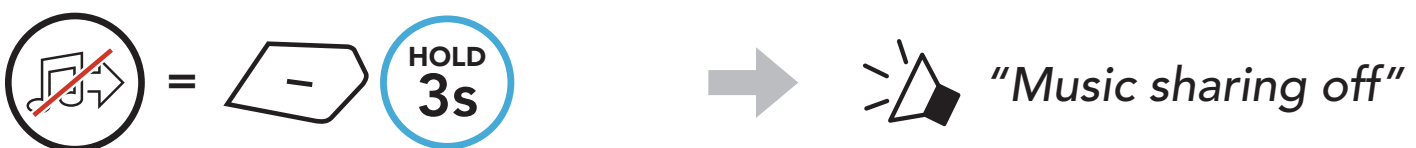

# 7. MESH INTERCOM

## 7.1 What is Mesh Intercom?

**Mesh Intercom** allows riders to connect and communicate with nearby users without the need to pair each headset together.

The working distance between each **SMART HJC 50B** in **Mesh Intercom** can be up to 2 km (1.2 miles) in open terrain. In open terrain, the **Mesh** can be extended up to 8 km (5 miles) between a minimum of six users. Within the same channel in **Open Mesh™** or the same private group in **Group Mesh™**, six users can talk at the same time and enjoy the optimal quality for their conversation.

### Mesh Intercom



## 7.1.1 Open Mesh

**Open Mesh** is an open group intercom function. Users can freely communicate with each other in the same **Open Mesh** channel and select which channel (1-9) to use through the headset.

It can connect with a virtually unlimited number of users in each channel.

### Open Mesh

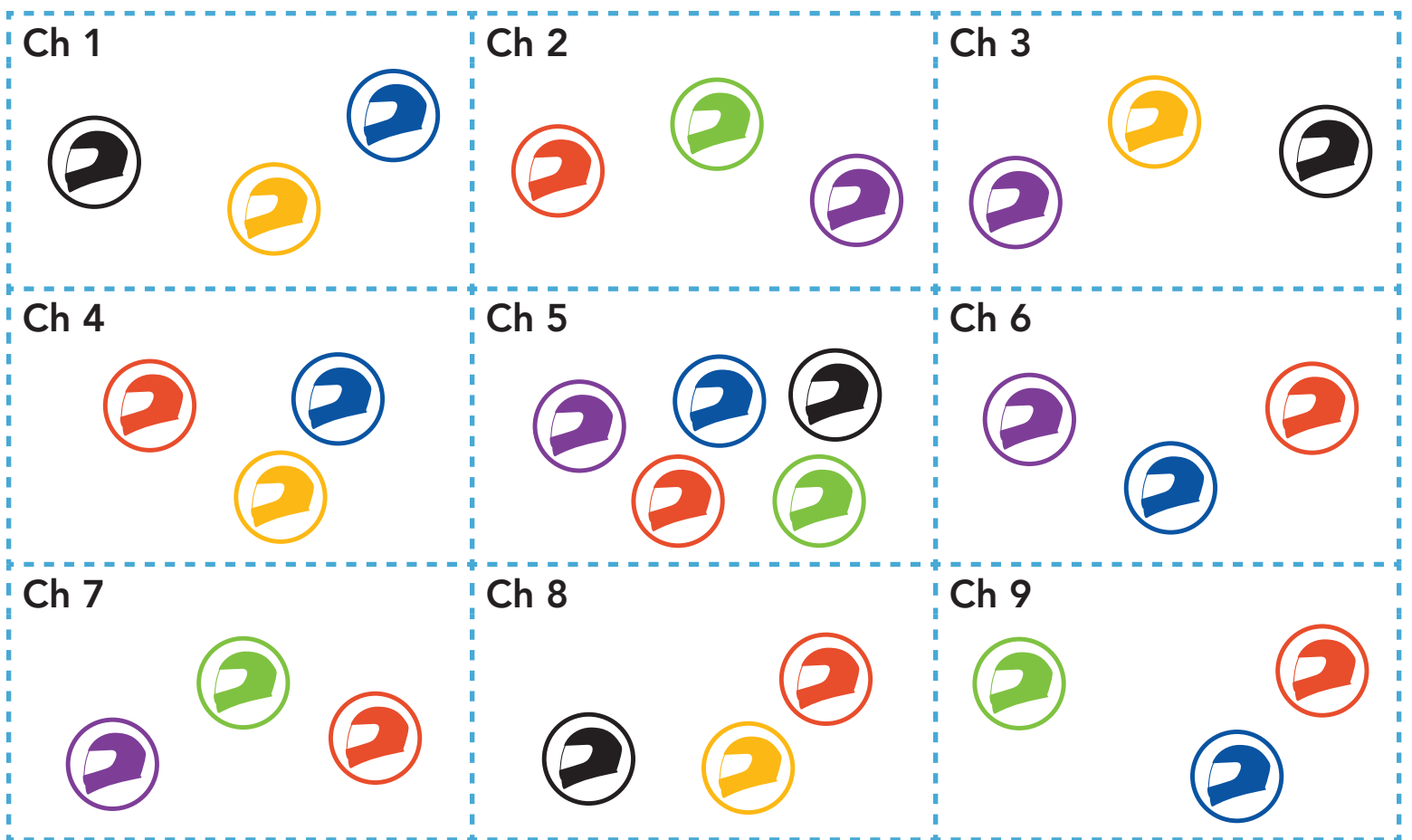

## 7.1.2 Group Mesh

**Group Mesh** is a closed group intercom function that allows users to join, leave, or rejoin a group intercom conversation without pairing each headset. Users can freely communicate with each other in the same private group in **Group Mesh**.

For closed intercom conversations using **Mesh Intercom**, a **Group Mesh** needs to be created by the users. When users create a private group in **Group Mesh** by **Mesh Grouping**, the headset automatically switches from **Open Mesh** to **Group Mesh**. Up to 24 users can all be connected in each private group.

### Group Mesh





## 7.2 Starting Mesh Intercom

When **Mesh Intercom** is enabled, the **SMART HJC 50B** will automatically connect to nearby **SMART HJC 50B** users and allow them to talk to each other by pressing the **M Button**.

### Mesh Intercom On

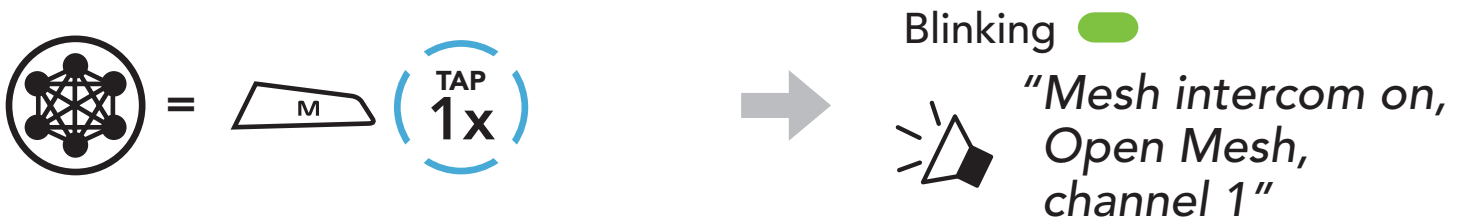

### Mesh Intercom Off

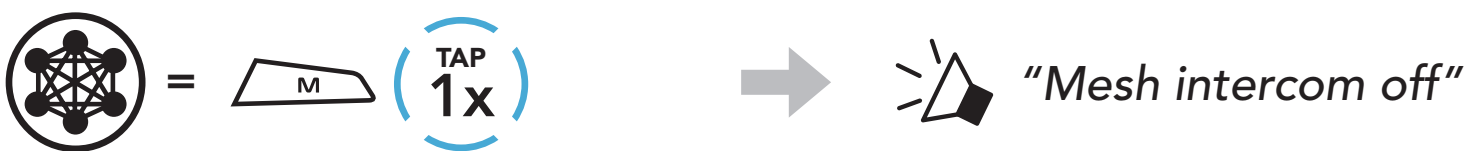

## 7.3 Using the Mesh in Open Mesh

When **Mesh Intercom** is enabled, the headset will be in **Open Mesh (default: channel 1)** initially.

### 7.3.1 Channel Setting (Default: channel 1)

If the **Open Mesh** communication experiences interference because other groups are also using **channel 1 (default)**, change the channel. You can select from channels 1 to 9.

1. Double tap the **M Button**.

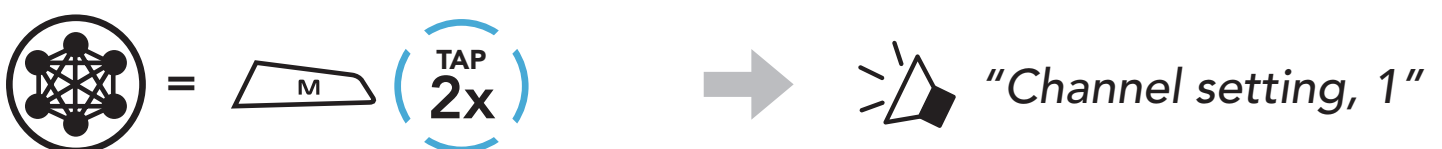

2. Navigate between channels.

(1 → 2 → ●●● → 8 → 9 → Exit → 1 → ●●●)

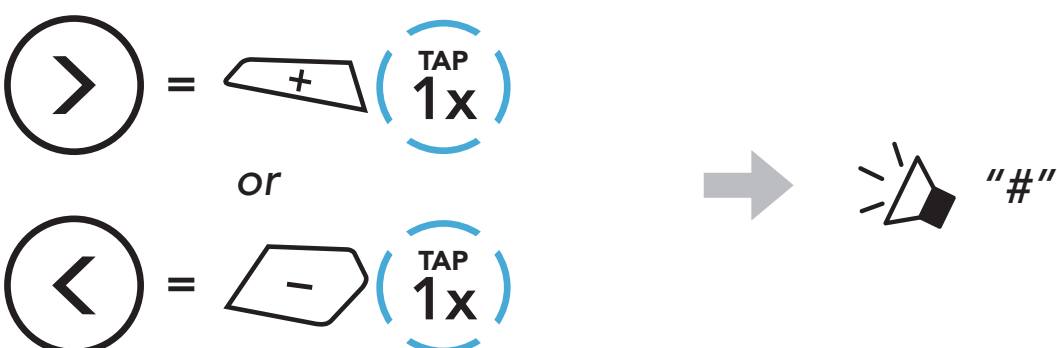

3. Save the channel.



**Note:**

- **Channel Setting** always starts with channel 1.
- If you do not press any button for approximately **10 seconds** in a specific channel, the channel is automatically saved.
- The channel will be remembered even if you turn off the **SMART HJC 50B**.
- You can use the **SMART HJC BT App** to change the channel.

## 7.4 Using Mesh in Group Mesh

### 7.4.1 Creating a Group Mesh

Creating a **Group Mesh** requires **two or more Open Mesh users**.

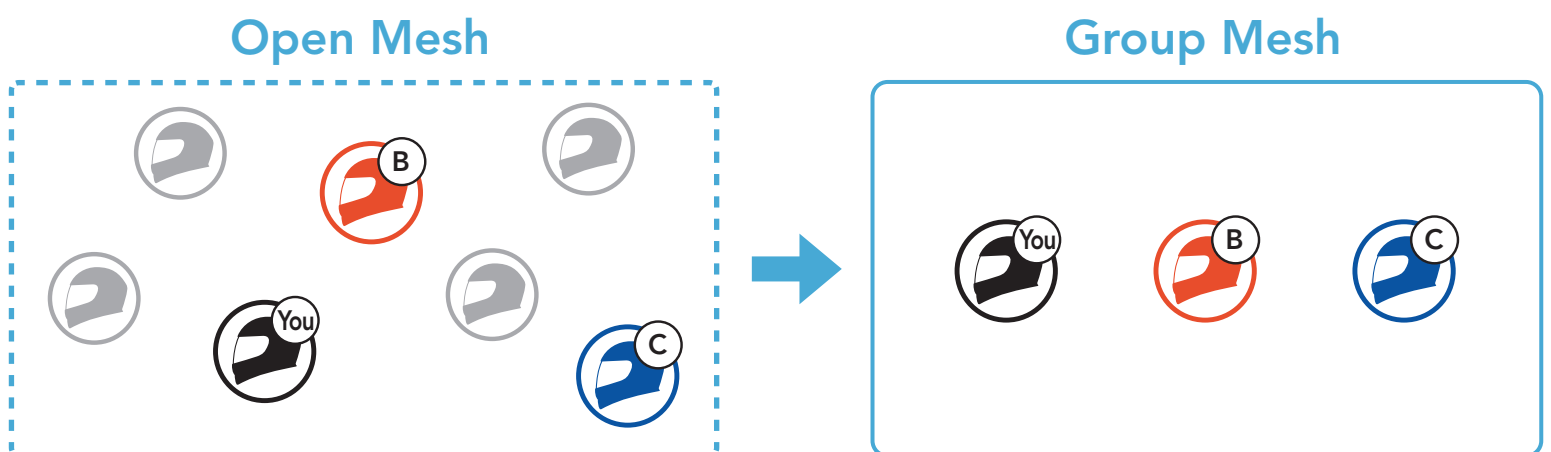

1. To enter **Mesh Grouping** to create a **Group Mesh**, press and hold the **M/F Button** for **5 seconds** on the headset of the **users (You, B, and C)**.

**Each user** simultaneously presses and holds the **M/F Button** for **5 seconds** until **users** hear the voice prompt, **"Mesh grouping."**



2. When **Mesh Grouping** is completed, the **users (You, B and C)** will hear a voice prompt on their headsets as **Open Mesh** switches to **Group Mesh**.



**Note:**

- If the **Mesh Grouping** is not completed within **30 seconds**, users will hear a voice prompt, **"Grouping failed"**.
- If you want to cancel during the **Mesh Grouping**, tap the **M/F Button**.

## 7.4.2 Joining an Existing Group Mesh

One of the **current users** in an **Existing Group Mesh** can allow **new users (one or more)** in **Open Mesh** to join the **Existing Group Mesh**.

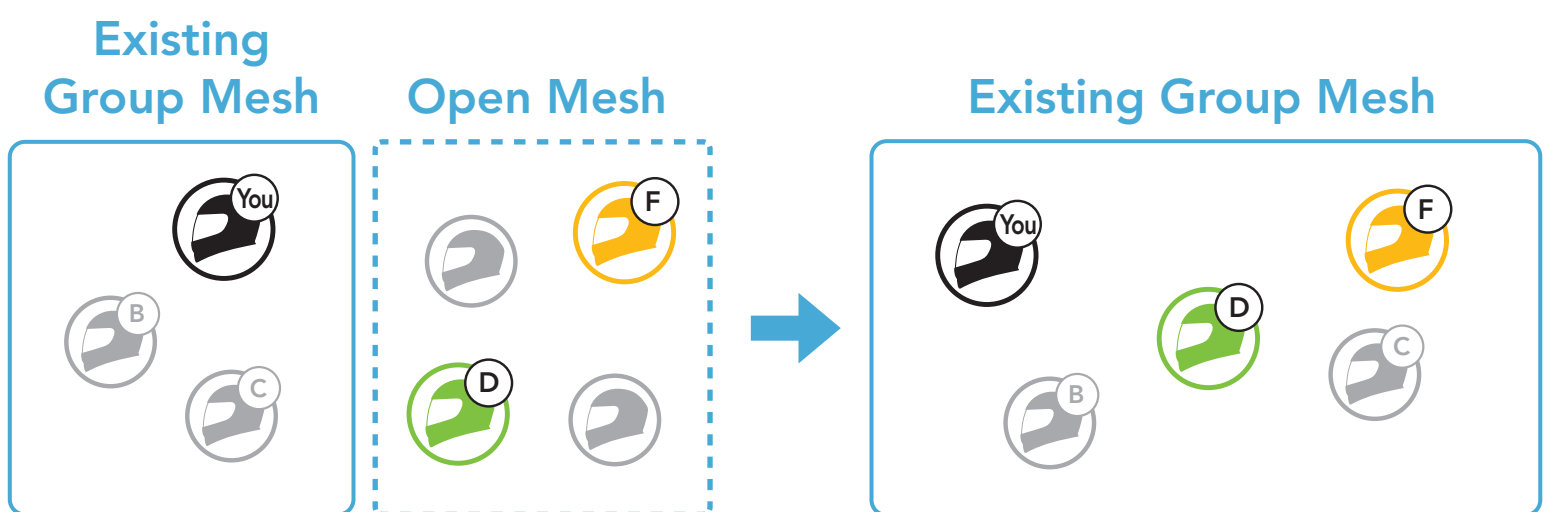

1. To enter **Mesh Grouping** to join the **Existing Group Mesh**, press and hold the **M/F Button** for **5 seconds** on the headsets of **one (You) of the current users** in the **Existing Group Mesh** and the **new users (D and F)** in **Open Mesh**.

**Each user** simultaneously presses and holds the **M/F Button** for **5 seconds** until **users** hear the voice prompt, **"Mesh grouping."**



2. When **Mesh Grouping** is completed, the **new users (D and F)** will hear a voice prompt on their headsets as **Open Mesh** switches to **Group Mesh**.



**Note:** If the **Mesh Grouping** is not completed within **30 seconds**, the current user (You) will hear a low tone double beep and the new users (D and F) will hear a voice prompt, **"Grouping failed"**.

## 7.5 Enable/Disable Mic (Default: Enable)

Users can enable/disable the microphone when communicating in a **Mesh Intercom**.

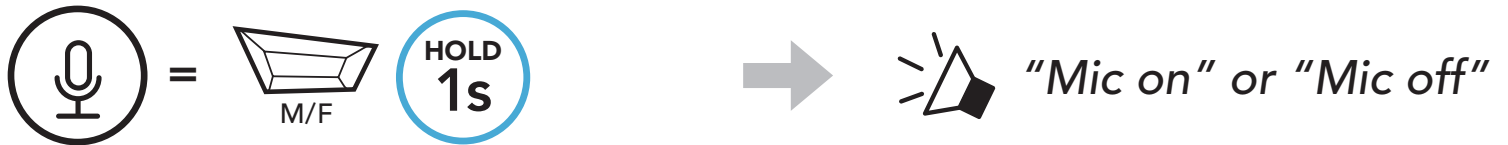

## 7.6 Toggling Open Mesh/Group Mesh

Users are able to toggle between **Open Mesh** and **Group Mesh** without resetting the **Mesh**. This allows users to keep the **Group Mesh Network** connection information while in **Open Mesh**.

Users can toggle to **Group Mesh** to communicate with participants from the stored **Group Mesh Network** connection information.

### Toggle Between Open Mesh and Group Mesh

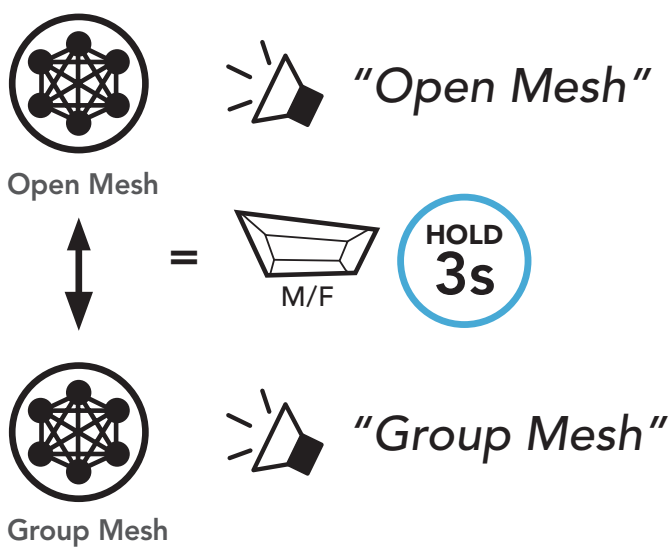

**Note:** If you have never participated in **Group Mesh**, you cannot toggle between **Open Mesh** and **Group Mesh**. You will hear a voice prompt, "No Group Available".

## 7.7 Reset Mesh

If the headset in an **Open Mesh** or **Group Mesh** resets the **Mesh**, it will automatically return to **Open Mesh (default: channel 1)**.



## 8. BLUETOOTH INTERCOM

Up to three other people can be paired with the headset for Bluetooth intercom conversations.

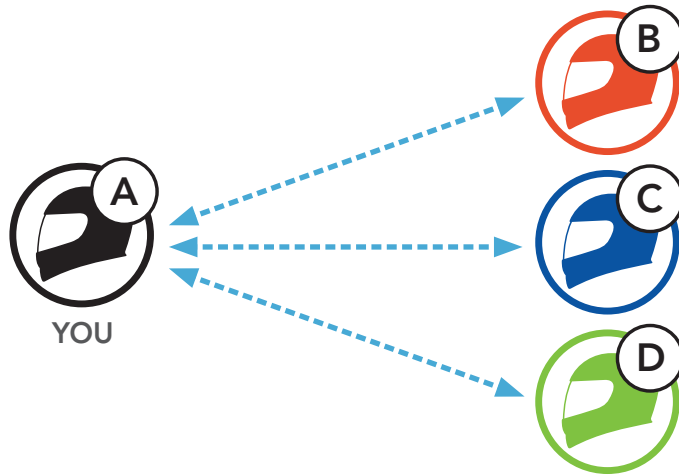



### 8.1 Intercom Pairing

There are two ways to pair the headset.

#### 8.1.1 Using the Smart Intercom Pairing (SIP)

**SIP** allows you to quickly pair with your friends for intercom communication by scanning the QR code on the **SMART HJC BT App** without remembering the button operation.

1. Pair the mobile phone with the headset.
2. Open the **SMART HJC BT App** and tap  (**Smart Intercom Pairing Menu**).
3. Scan the **QR code** displayed on your friend (**B**)'s mobile phone.
  - Your friend (**B**) can display the QR code on the mobile phone by tapping  > **QR code** () on the **SMART HJC BT App**.

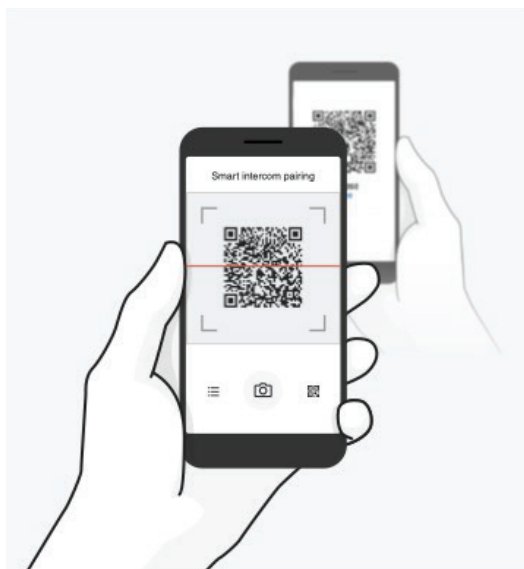

4. Tap **Save** and check that your friend **(B)** is paired with **you (A)** correctly.
5. Tap **Scan** (📷) and repeat steps 3-4 to pair with **Intercom Friends (C)** and **(D)**.

**Note:** The **Smart Intercom Pairing (SIP)** is not compatible with SMART HJC headsets that use **Bluetooth 3.0** or **below**.

### 8.1.2 Using the Button



1. **Each user** simultaneously presses and holds the **TAP Button** for **5 seconds** until users hear the voice prompt, **"Intercom Pairing."**



Blinking 

 "Intercom pairing"

Turns blue 

2. The **two headsets (A and B)** will be automatically paired.



3. Repeat the steps above to pair with **other headsets (C and D)**.

## 8.2 Last-Come, First-Served

The intercom pairing queue is **Last-Come, First-Served**. If the headset has multiple paired headsets for intercom conversations, the last paired headset is set as the **First Intercom Friend**. For example, after the pairing procedures listed above, **headset (D)** is the **First Intercom Friend** of headset (A), **headset (C)** is the **Second Intercom Friend** of headset (A), and **headset (B)** is the **Third Intercom Friend** of headset (A).

### Intercom Pairing Order

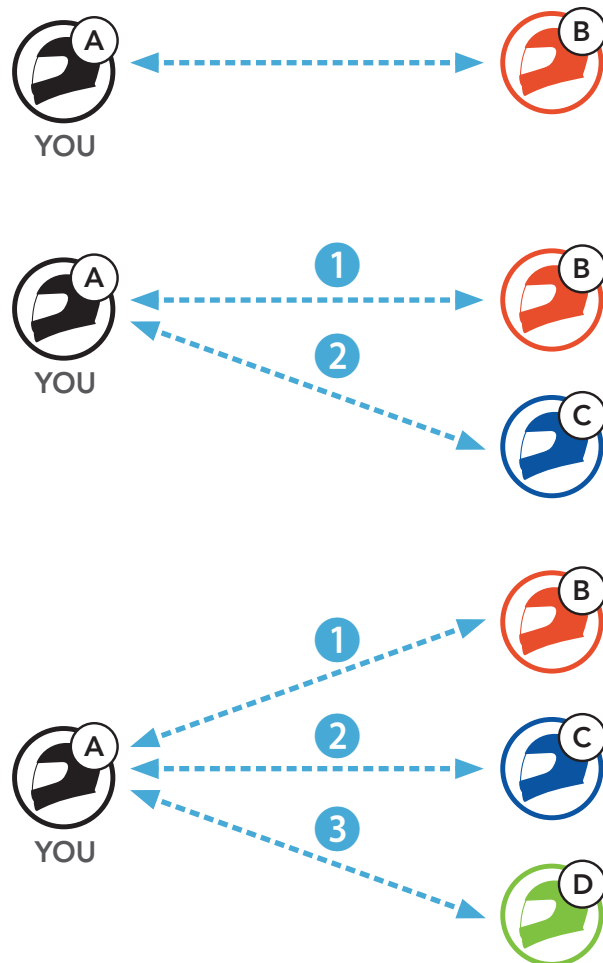

### Last-Come, First-Served

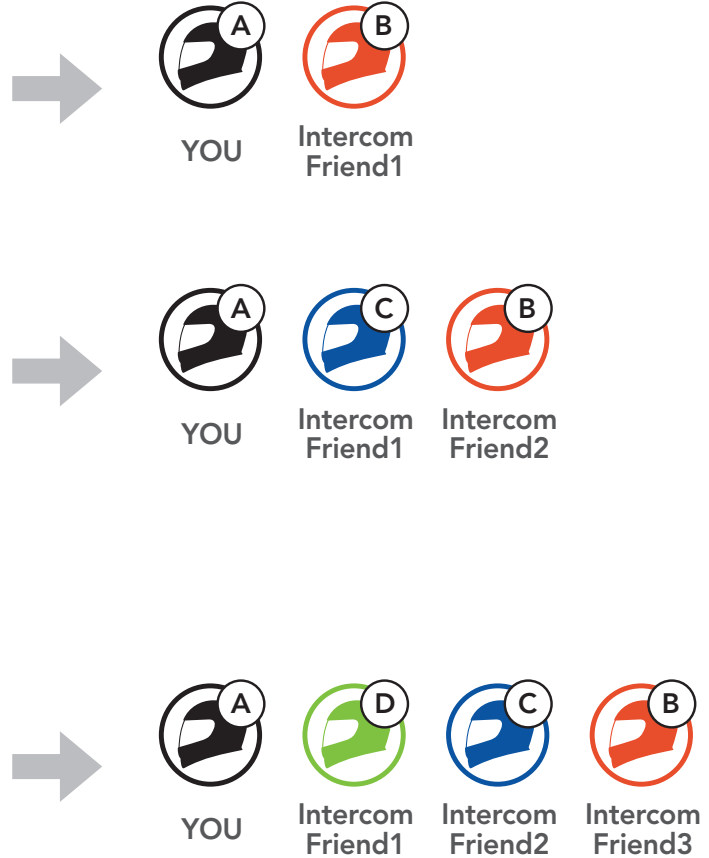

## 8.3 Two-Way Intercom

You can start or end an intercom conversation with an **Intercom Friend**.



### Start/End Conversation with the First Intercom Friend D

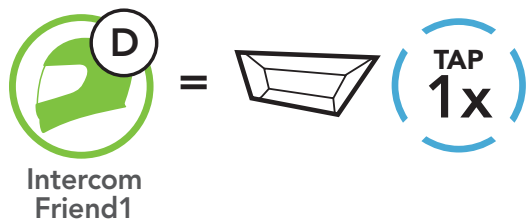

### Start/End Conversation with the Second Intercom Friend C

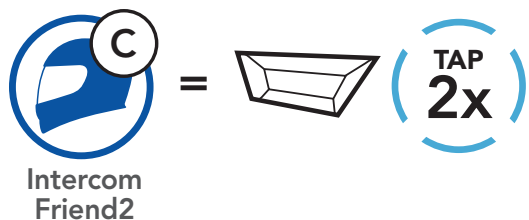

### Start/End Conversation with the Third Intercom Friend B

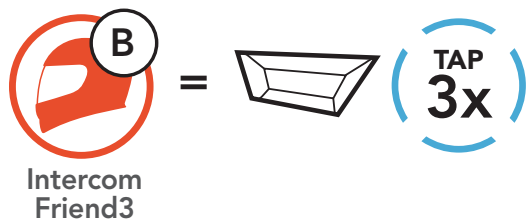



## 8.4 Multi-Way Intercom

**Multi-Way Intercom** enables conference-call-style conversations with up to **three Intercom Friends** at the same time. While **Multi-Way Intercom** is in progress, the mobile phone connection is temporarily disconnected. However, as soon as **Multi-Way Intercom** terminates, the mobile phone connection will be reestablished.

### 8.4.1 Starting a Three-Way Intercom Conference

**You (A)** can have a **Three-Way Intercom Conference** with two other **Intercom Friends (B and C)** by establishing two intercom connections simultaneously.

- You (A)** need to be paired with two other **Intercom Friends (B and C)** for the **Three-Way Intercom Conference**.



- Start an intercom conversation with the **First Intercom Friend (C)** by tapping the **TAP Button**.



- You (A)** can call the **Second Intercom Friend (B)** by double tapping the **TAP Button**, or the **Second Intercom Friend (B)** may join the intercom by making an intercom call to **you (A)**.



- Now **you (A)** and **two Intercom Friends (B and C)** are having a **Three-Way Intercom Conference**.



## 8.4.2 Starting a Four-Way Intercom Conference

With **three Intercom Friends** connected, a new participant (**D**) can make it a **Four-Way Intercom Conference** by making an intercom call to either (**B**) or (**C**).

1. **Intercom friend (B)** needs to be paired with a **new participant (D)**.

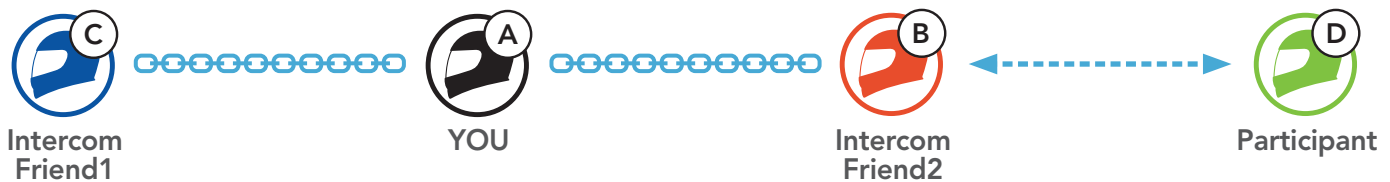

2. **Intercom friend (B)** can call a **new participant (D)** by tapping the **TAP Button**, or a **new participant (D)** may join the intercom by making an intercom call to **Intercom friend (B)**.

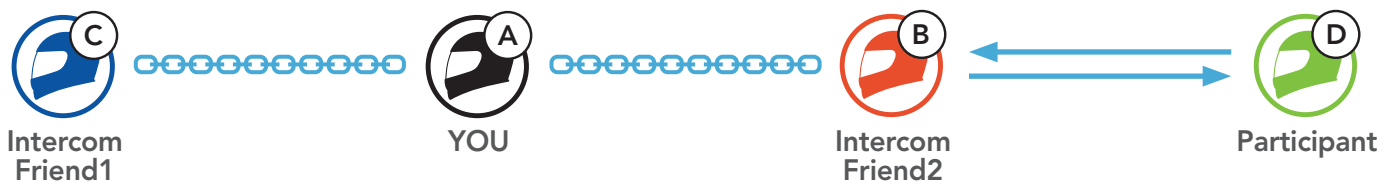

3. Now **you (A)**, **two Intercom Friends (B and C)**, and a **new participant (D)** are having a **Four-Way Intercom Conference**.

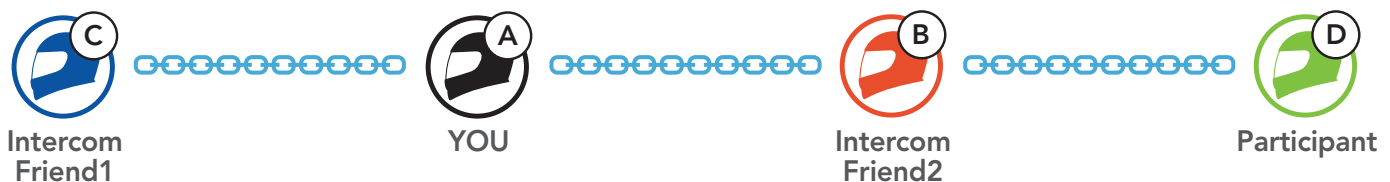

## 8.4.3 Ending Multi-Way Intercom

You can completely terminate the conference intercom or just disconnect an intercom connection with one of your active **Intercom Friends**.

### Terminate All Intercom Connections

- Press and hold the **TAP Button** for **3 seconds**.

### Disconnect the Intercom Connection with One of the Intercom Friends

- Disconnect (C): Tap the **TAP Button**.
- Disconnect (B) & (D): Double tap the **TAP Button**.

**Note:** When you disconnect the **second friend (B)**, you will be disconnected with the **third participant (D)** as well. This is because the **third participant (D)** is connected with you via the **second friend (B)**.

## 8.5 Three-Way Conference Phone Call with Intercom Users

You can have a **Three-Way Conference Phone Call** by adding an **Intercom Friend** to the mobile phone conversation.

1. During a mobile phone call, tap the **TAP Button once, twice, or three times** to invite one of your **Intercom Friends** to the conversation.

### Invite an Intercom Friend into Phone Conference

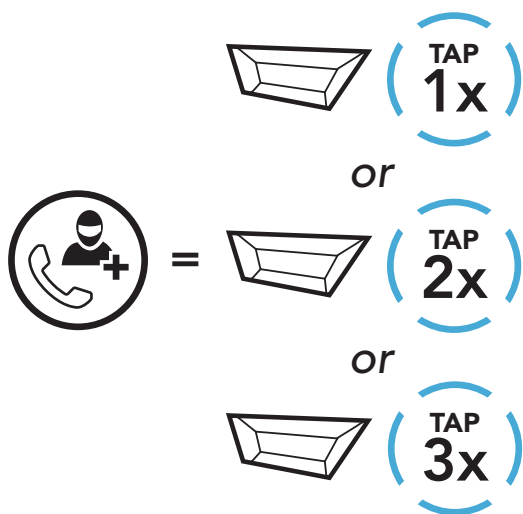

2. To disconnect the intercom during a conference phone call, tap the **TAP Button once, twice, or three times**.

### Disconnect the Intercom Friend from Conference

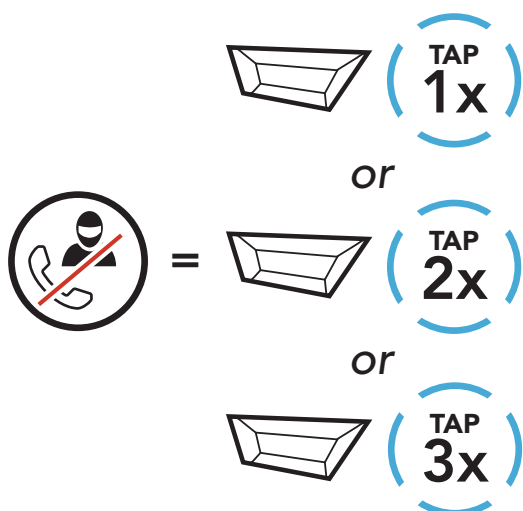

3. To disconnect the mobile phone call during a conference phone call, press and hold the **TAP Button** for **2 seconds**.

### End Phone Call from Conference

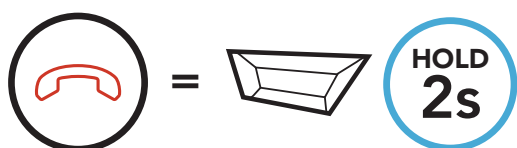

**Note:** When you have an incoming intercom call during a mobile phone call, you will hear high tone double beeps.

## 8.6 Group Intercom

**Group Intercom** allows you to instantly create a **Multi-Way Conference Intercom** with three of the most recently paired headsets.

### To Start the Group Intercom

1. Go through intercom pairing with up to three headsets you want to have **Group Intercom** with.

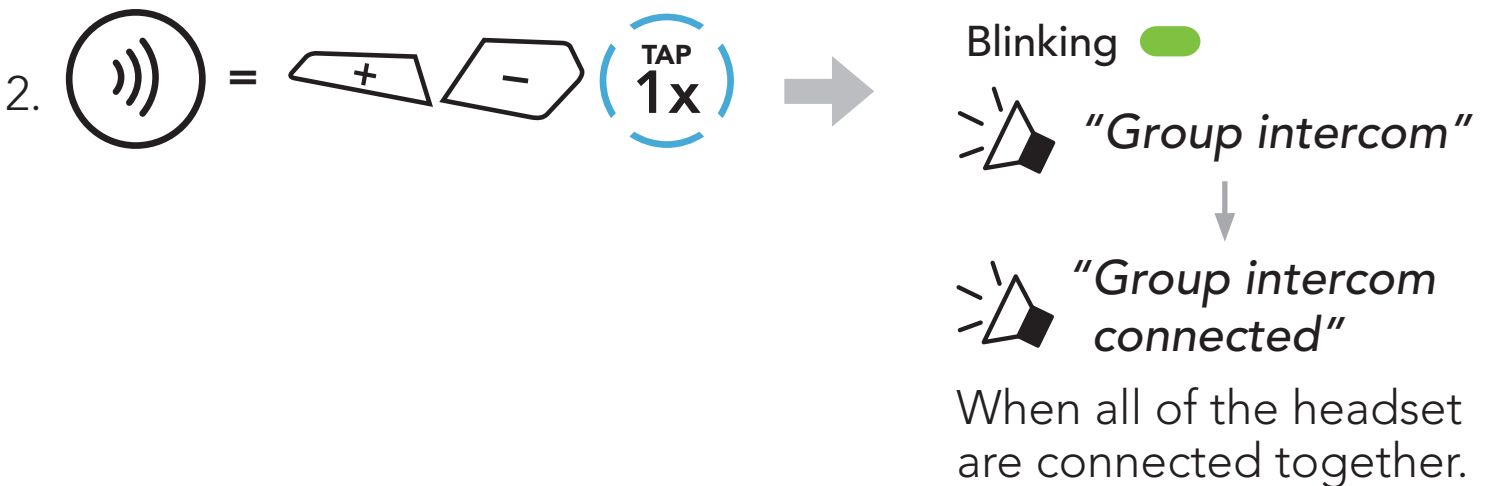

### Terminate Group Intercom



## 8.7 Mesh Intercom Conference with Bluetooth Intercom Participant

Users can use the existing Bluetooth intercom and **Mesh Intercom** function at the same time. In this case, it is recommended to communicate with other SMART HJC headset via Bluetooth intercom connection and use **Mesh Intercom** between **SMART HJC 50B** headset. A user who is in **Open Mesh** or **Group Mesh** when using Mesh Intercom is able to include up to 3 of their Bluetooth intercom friends. You can start a Two-Way Intercom conversation with one of your three Intercom Friends to include them in the Mesh.

**Note:**

- The audio quality will be reduced if a **SMART HJC 50B** connects to 2 or more Bluetooth intercom friends while in **Open Mesh** or **Group Mesh** when using **Mesh Intercom**.
- If a closed loop is created, as shown below, each user will experience severe noise issues. SMART HJC recommends that a closed loop not be created.

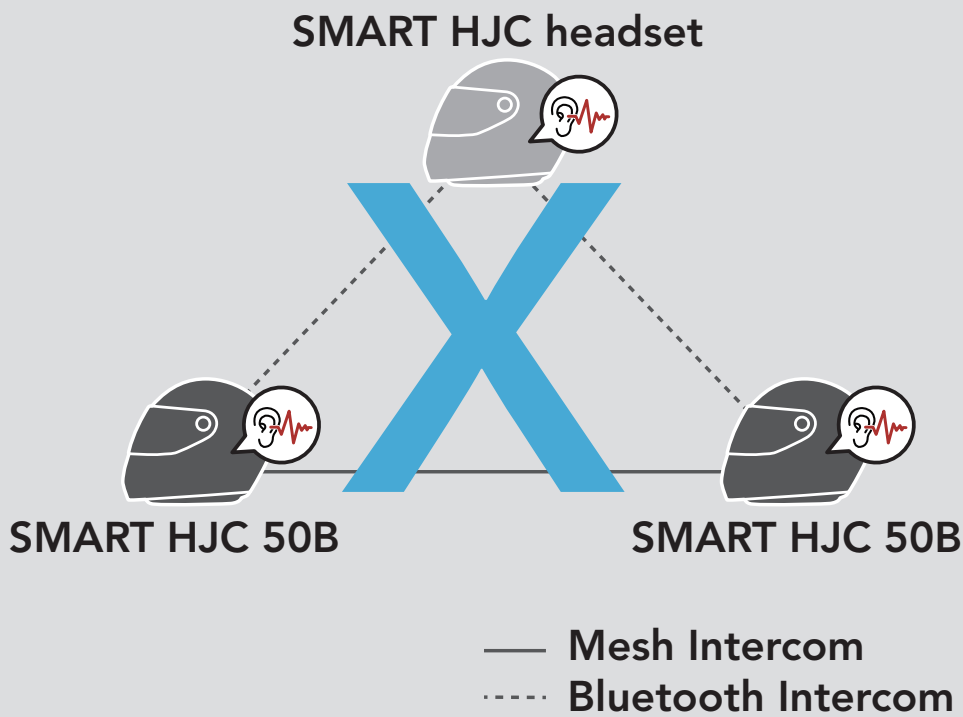



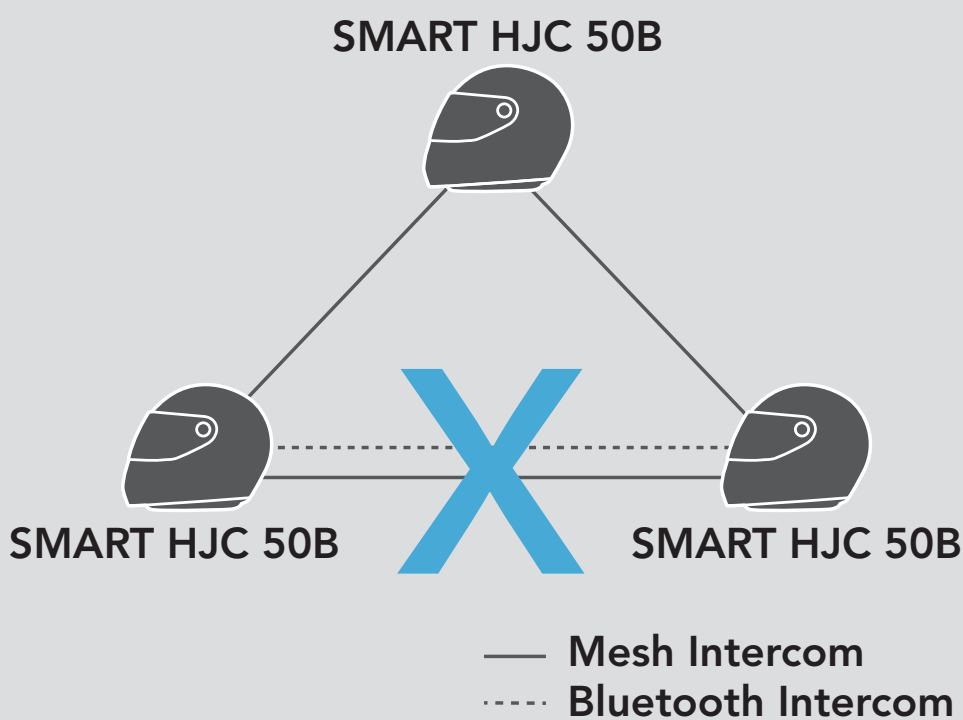







- If **Bluetooth intercom** is accidentally turned on during **Mesh Intercom** communication between **SMART HJC 50B** headsets, as shown below, you will hear a voice prompt, **“Mesh intercom disabled. Bluetooth intercom connected”** every **1 minute**. If you turn off the **Bluetooth Intercom** or turn off the **Mesh Intercom**, the voice prompt will no longer come out.



## 9. UNIVERSAL INTERCOM

**Universal Intercom** allows you to have intercom conversations with users of non-SMART HJC Bluetooth headsets. Non-SMART HJC Bluetooth headset can be connected to the SMART HJC headset if they support the **Bluetooth Hands-Free Profile (HFP)**. You can pair the headset with only one non-SMART HJC headset at a time. The intercom distance depends on the performance of the headset to which it's connected. When a non-SMART HJC headset is paired with the headset while another Bluetooth device is paired via **Second Mobile Phone Pairing**, it will be disconnected.

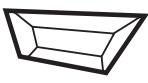
### 9.1 Universal Intercom Pairing

-  =   →  "Configuration menu"
-  =   →  "Universal intercom pairing"
-  =   → Enter into **Universal Intercom Pairing** mode.

4. Put the non-SMART HJC headset in Hands-free Pairing Mode. The headset will automatically pair with a non-SMART HJC Bluetooth headset.

### 9.2 Two-Way Universal Intercom

You can initiate the **Universal Intercom** connection with non-SMART HJC Bluetooth headsets using the same intercom connection method as you would between other SMART HJC headsets.

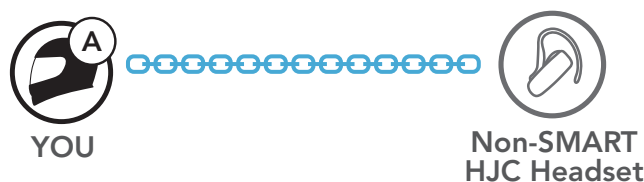

You may start/end a **Two-Way Universal Intercom** using the same way as you do in a normal **Two-Way Intercom**. Please refer to **Section 8.3: "Two-Way Intercom"**.

## 9.3 Multi-Way Universal Intercom

You can have **Multi-Way Intercom** communication with up to **three Intercom Friends** using non-SMART HJC headsets. Some non-SMART HJC headsets may not support **Multi-Way Universal Intercom**.

You may make the **Multi-Way Universal Intercom** call the same way as a normal four-way intercom call.

You may start/end a **Multi-Way Universal Intercom** using the same way as you do in a normal **Multi-Way Intercom**. Please refer to **Section 8.4: "Multi-Way Intercom"**.

### 9.3.1 Three-Way Universal Intercom

You may make a **Three-Way Universal Intercom** connection with two headsets and one non-SMART HJC Bluetooth headset. If the intercom connection is made, all headsets connected cannot use the mobile phone call function since the connection between the headset and the phone is disconnected temporarily. If you disconnect the intercom call, the mobile phone connection is made again automatically so that you can use a mobile phone call function.

1. **You (A)** need to be paired with a non-SMART HJC Bluetooth headset **(B)** and another headset **(C)** for the **Three-Way Conference Intercom**.

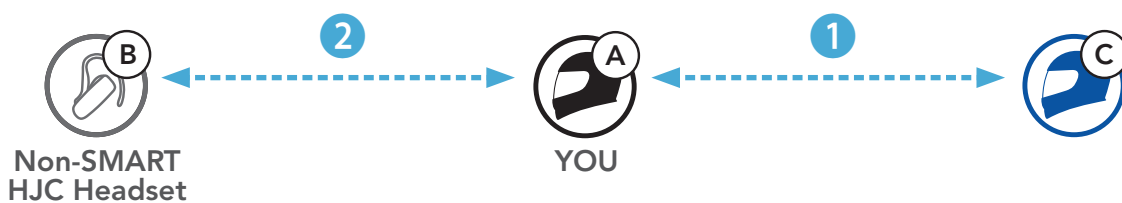

2. Start an intercom conversation with a non-SMART HJC Bluetooth headset **(B)** in your intercom group. For example, **you (A)** may start an intercom conversation with non-SMART HJC Bluetooth headset **(B)**. The non-SMART HJC Bluetooth headset **(B)** may also start an intercom call with **you (A)**.

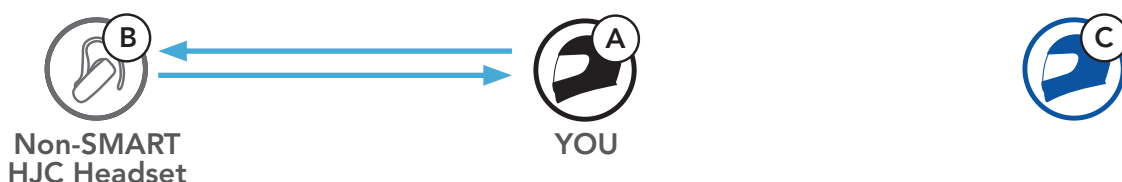

3. The other headset **(C)** may join the intercom by making an intercom call to **you (A)**.



4. Now **you (A)**, non-SMART HJC Bluetooth headset **(B)**, and the other headset **(C)** are having a **Three-Way Conference Intercom**.



### 9.3.2 Four-Way Universal Intercom

You may make the **Four-Way Universal Intercom** call the same way as a normal **Four-Way Intercom** call.

You may make a **Four-Way Universal Intercom** connection with a couple of different configurations,

- 1) two headsets and two non-SMART HJC Bluetooth headsets or
- 2) three headsets and one non-SMART HJC Bluetooth headset.

#### Four-Way Universal Intercom Case 1

1) **You (A)**, a non-SMART HJC Bluetooth headset **(B)**, another headset **(C)**, and a non-SMART HJC Bluetooth headset **(D)**.

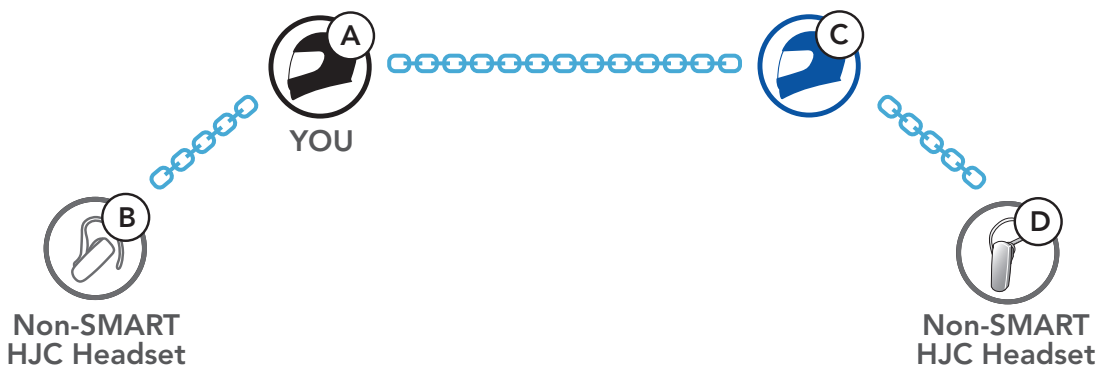

#### Four-Way Universal Intercom Case 2

2) **You (A)**, a non-SMART HJC Bluetooth headset **(B)**, and **two other headsets (C and D)**.





## 9.4 Mesh Intercom Conference with Two-way Universal Intercom Participant

Users can use the existing **Two-way Universal Intercom** and **Mesh Intercom** function at the same time. In this case, it is recommended to communicate with **non-SMART HJC headset** via **Two-way Universal Intercom** connection and use **Mesh Intercom** between **SMART HJC 50B headsets**.

A user who is in **Open Mesh** or **Group Mesh** when using **Mesh Intercom** is able to include one **Universal Intercom friend**. You can start a **Two-way Universal Intercom** conversation with your **Universal Intercom Friend** to include it in the **Mesh**.

# 10. USING THE FM RADIO

## 10.1 FM Radio On/Off

### FM Radio On



### FM Radio Off



## 10.2 Seek and Save Radio Stations

The **"Seek"** feature searches for radio stations.

1. Search for radio stations.

### Seek Stations Forward

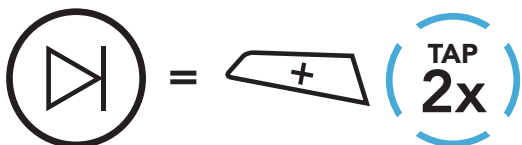

### Seek Stations Backward

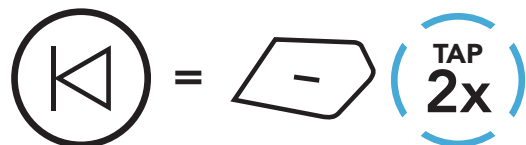

2. Save the current station.

### Enter Preset Selection Mode



3. Navigate through the preset numbers that you want to store.

### Navigate Forward/Backward Through Preset Stations

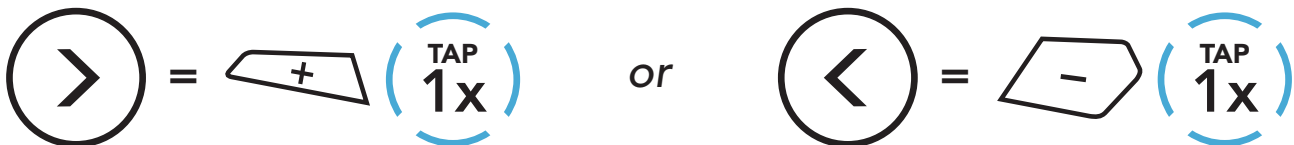

4. Save the station in the preset number you choose or delete the station from memory.

### Save Station to the Preset Number

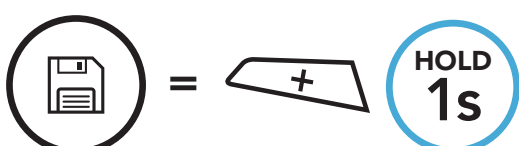

### Delete Station from Memory

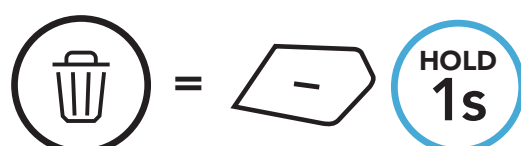

## 10.3 Scan and Save Radio Stations

The **“Scan”** function automatically searches for radio stations, starting with the current station’s frequency, then up from there.

1. Scan for stations.

### Start Scanning

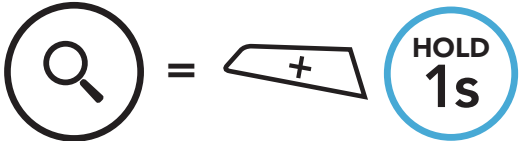

### Stop scanning

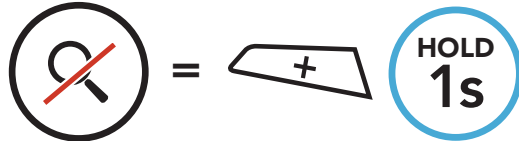

2. The tuner pauses at each station it finds for **8 seconds** before moving to the next.
3. Save the current station. The station will be saved as the next preset number.

### Save the Current Station



**Note:** You can use the **SMART HJC BT App** to save the preset stations.

## 10.4 Temporary Station Preset

The **Temporary Preset** feature automatically finds and saves the nearest 10 radio stations without changing your existing preset stations.

1. Automatically find and save 10 stations.

### Temporary Stations

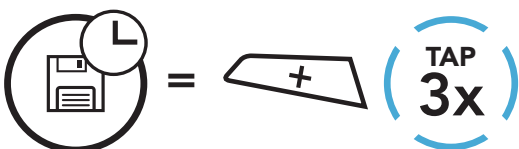

2. The temporary preset stations will be cleared when the headset reboots.

## 10.5 Navigating Preset Stations

Using the methods above, up to 10 radio stations can be stored. You can navigate through the saved stations.

### Navigate through Preset Stations

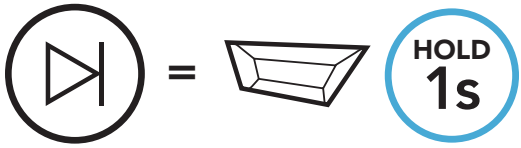

# 11. VOICE COMMAND

The **Voice Command** of the headset allows you to operate certain operations by simply using your voice. You can control the headset completely hands-free using the voice recognition. Multi-language Voice Command supports **English, French, German, Spanish, Italian, Chinese, Japanese, and Russian.**

## Speak a Voice Command List

Mode Status	Function	Voice Command
Standby/ Bluetooth Intercom/ Mesh Intercom/ FM Radio/ Music	Check battery	"Hey Sena, Check Battery"
	Volume Up	"Hey Sena, Volume Up"
	Volume Down	"Hey Sena, Volume Down"
	Phone Pairing	"Hey Sena, Phone Pairing"
	Bluetooth Intercom Pairing	"Hey Sena, Pairing Intercom"
	Start/End each Bluetooth Intercom	"Hey Sena, Intercom [one, two, three]"
Standby/ Bluetooth Intercom/ FM Radio/ Music	Turn on Mesh Intercom	"Hey Sena, Mesh On"
Mesh Intercom	Turn off Mesh Intercom	"Hey Sena, Mesh Off"
	Mesh Grouping	"Hey Sena, Mesh Grouping"
	Switch to Open Mesh	"Hey Sena, Open Mesh"
	Switch to Group Mesh	"Hey Sena, Group Mesh"
	End the Bluetooth intercom and Mesh intercom	"Hey Sena, End intercom"
Standby/ Bluetooth Intercom/ Mesh Intercom	Play Music	"Hey Sena, Play Music"
Standby/ Intercom/ Mesh Intercom/ Music	Turn on FM radio	"Hey Sena, FM Radio On"

Mode Status	Function	Voice Command
Music/ FM Radio	<ul style="list-style-type: none"> <li>FM - Next Preset</li> <li>Music - Next Track</li> </ul>	"Hey Sena, Next"
	<ul style="list-style-type: none"> <li>FM - Previous Preset</li> <li>Music - Previous Track</li> </ul>	"Hey Sena, Previous"
Music	Pause Music	"Hey Sena, Stop Music"
FM Radio	Turn off FM Radio	"Hey Sena, FM Radio Off"
Answer an Incoming Call		"Answer"
Ignore an Incoming Call		"Ignore"

**Note:**

- You can set a language to another language by using the **Headset Language** feature on the **SMART HJC BT App**.
- If you set a language that does not support voice commands, the voice command will work only with English commands.
- You can see the another language's voice command list on the **SMART HJC BT App**.
- **Voice command** performance may vary based on the environmental conditions.

# 12. FUNCTION PRIORITY AND FIRMWARE UPGRADES

## 12.1 Function Priority

The headset operates in the following order of priority:

- (highest) Mobile phone
- Mesh Intercom/Bluetooth Intercom
- Music sharing via Bluetooth stereo
- FM radio
- (lowest) Bluetooth stereo music

A lower-priority function gets interrupted by a higher-priority function. For example, stereo music will be interrupted by an **Intercom Conversation**; an **Intercom Conversation** will be interrupted by an incoming mobile phone call.

## 12.2 Firmware Upgrades

You can upgrade firmware using the **SMART HJC Device Manager**.

The **USB Power & Data Cable (USB-C)** must be connected to your **PC** to upgrade firmware using the **SMART HJC Device Manager**.

Please visit [www.smarthjc.com](http://www.smarthjc.com) to check for the latest software downloads.

[Click Here to Visit www.smarthjc.com](http://www.smarthjc.com)

# 13. CONFIGURATION SETTING

## 13.1 Headset Configuration Menu

### Accessing the Configuration Menu

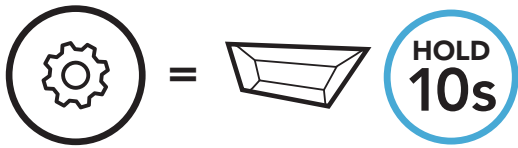

### Navigating Between Menu Options

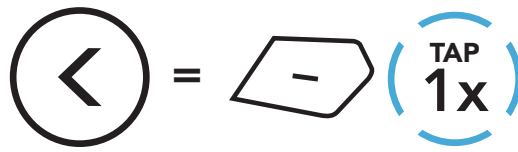
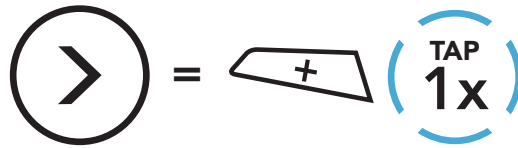

### Execute Menu Options

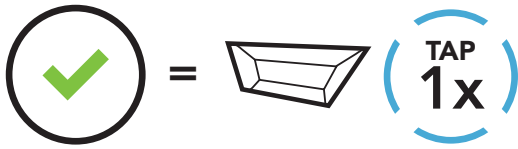

### Headset Configuration Menu

Voice Configuration Menu	Tap the TAP Button
Mobile Phone Pairing	None
Second Mobile Phone Pairing	None
Phone Selective Pairing	None
Media Selective Pairing	None
GPS Pairing	None
Delete All Pairings	Execute
Remote Control Pairing	Execute
Universal Intercom Pairing	Execute
Factory Reset	Execute
Exit Configuration	Execute



### 13.1.1 Delete All Pairings

You can delete all Bluetooth pairing information of the headset.

### 13.1.2 Remote Control Pairing

You can remotely control the headset using **Sena Remote Control devices** (sold separately).

1. Turn on the headset and the Remote Control device.
2. Execute **Remote Control Pairing**.
3. Enter pairing mode in the Remote Control device. The headset will automatically connect with the Remote Control device in pairing mode.

## 13.2 Software Configuration Setting

You can change the settings of the headset through the **SMART HJC BT App** or the **SMART HJC Device Manager**.



### 13.2.1 Headset Language

You can select the device language. The selected language is maintained even when the headset is rebooted.

### 13.2.2 Audio Equalizer (Default: Off)

Increase or decrease the decibel level of different frequency ranges of audio.

- **Balance** will adjust all of the frequency ranges to be the same volume level (0 dB).
- **Bass Boost** will increase the bass range of audio (20 Hz - 250 Hz).
- **Mid Boost** will increase the mid range of audio (250 Hz - 4 kHz).
- **Treble Boost** will increase the high range of audio (4 kHz - 20 kHz).

### 13.2.3 VOX Phone (Default: Enable)

If this feature is enabled, you can answer incoming calls by voice. When you hear a ringtone for an incoming call, you can answer the phone by saying a word such as **"Hello"** loudly or by blowing air into the microphone. **VOX Phone** is temporarily disabled if you are connected to intercom. If this feature is disabled, you have to tap the **TAP Button** to answer an incoming call.

### 13.2.4 VOX Intercom (Default: Disable)

If this feature is enabled, you can initiate an intercom conversation with the last connected intercom friend by voice. When you want to start intercom, say a word such as **"Hello"** loudly or blow air into the microphone. If you start an intercom conversation by voice, the intercom terminates automatically when you and your intercom friend remain silent for 20 seconds. However, if you manually start an intercom conversation by tapping the **TAP Button**, you have to terminate the intercom conversation manually. However, if you start the intercom by voice and end it manually by tapping the **TAP Button**, you will not be able to start intercom by voice temporarily. In this case, you have to tap the **TAP Button** to restart the intercom. This is to prevent repeated unintentional intercom connections by strong wind noise. After rebooting the headset, you can start intercom by voice again.

### 13.2.5 VOX Sensitivity (Default: 3)

**VOX Sensitivity** can be adjusted depending on your riding environment. **Level 5** is the highest sensitivity setting and **level 1** is the lowest.

### 13.2.6 HD Intercom (Default: Enable)

**HD Intercom** enhances the two-way intercom audio from normal quality to HD quality. **HD Intercom** will become temporarily disabled when you enter into a multi-way intercom. If this feature is disabled, the two-way intercom audio will change to normal quality.

**Note:**

- The intercom distance of **HD Intercom** is relatively shorter than that of normal intercom.
- **HD Intercom** will become disabled temporarily when **Bluetooth Intercom Audio Multitasking** is enabled.

### 13.2.7 HD Voice (Default: Enable)

**HD Voice** allows you to communicate in high-definition during phone calls. This feature increases the quality so that the audio will be crisp and clear during phone call conversations. If this feature is enabled, incoming phone calls will interrupt intercom conversations and audio from the SR10 will not be heard during intercom conversations. **Three-Way Conference Phone Call with Intercom Participant** will not be available if **HD Voice** is enabled.

**Note:**

- Refer to the manufacturer of your Bluetooth device that will be connected to the headset to see if it supports **HD Voice**.
- **HD Voice** is active only when **Bluetooth Intercom Audio Multitasking** is disabled.

### 13.2.8 Bluetooth Intercom Audio Multitasking (Default: Disable)

**Audio Multitasking (Bluetooth Intercom Audio Multitasking and Mesh Intercom Audio Multitasking)** allows you to have an intercom conversation while simultaneously listening to music, FM radio, or GPS instructions. The overlaid audio is played in the background with reduced volume whenever there is an intercom conversation and will return to normal volume once the conversation is finished.

The **Mesh Intercom Audio Multitasking** feature is **always on**.

#### Note:

- For **Bluetooth Intercom Audio Multitasking** to work properly, you need to power the headset off and on. **Please restart the headset.**
- **Bluetooth Intercom Audio Multitasking** will be activated during two-way intercom conversations with a headset that also supports this feature.
- Some GPS devices may not support this feature.
- The **Audio Multitasking** feature can be configured through the **Intercom-Audio Overlay Sensitivity** and the **Audio Overlay Volume Management settings**.

### 13.2.9 Intercom-Audio Overlay Sensitivity (Default: 3)

The music, FM radio and GPS volume will be lowered to play in the background if you talk over the intercom while the overlaid audio is playing. You can adjust the intercom sensitivity to activate this background audio mode. **Level 1** has the lowest sensitivity and **level 5** has the highest sensitivity.

**Note:** If your voice is not louder than the sensitivity of the selected level, the overlaid audio will not be lowered.

### 13.2.10 Audio Overlay Volume Management (Default: Disable)

The music, FM radio and GPS overlaid audio reduces in volume whenever there is an ongoing intercom conversation. If **Audio Overlay Volume Management** is enabled, the volume level of the overlaid audio will not be reduced during an intercom conversation.

### 13.2.11 Smart Volume Control (Default: Disable)

Enabling **Smart Volume Control** automatically changes the level of the speaker volume based on the level of the environment noise. You can enable it by setting the sensitivity to **low**, **medium** or **high**.

### 13.2.12 Sidetone (Default: Disable)

**Sidetone** is audible feedback of your own voice. It helps you to naturally speak at the correct level according to varying helmet noise conditions. If this feature is enabled, you can hear what you are speaking during an intercom conversation or a phone call.

### 13.2.13 Voice Prompt (Default: Enable)

You can disable **Voice Prompts** by software configuration settings, but the following voice prompts are always on.

- Headset configuration settings menu, battery level indicator, speed dial, FM radio functions

### 13.2.14 RDS AF Setting (Default: Disable)

**Radio Data System (RDS) Alternative Frequency (AF) Setting** allows a receiver to re-tune to the second frequency location when the first signal becomes too weak. With RDS AF enabled on the receiver, a radio station with more than one frequency can be used.

### 13.2.15 FM Station Guide (Default: Enable)

When **FM Station Guide** is enabled, FM station frequencies are given by voice prompts as you select preset stations. When **FM Station Guide** is disabled, the voice prompts on FM station frequencies will not be given as you select preset stations.

### 13.2.16 Advanced Noise Control™ (Default: Enable)

When **Advanced Noise Control** is enabled, the background noise is reduced during an intercom conversation. When it is disabled, the background noise is mixed with your voice during intercom.

### 13.2.17 Region Selection

You can select the proper FM frequency range for your location. Using the region setting, you can optimize the seek function to avoid unnecessary frequency ranges.

Region	Frequency range	Step
Worldwide	76.0 ~ 108.0 MHz	± 100 kHz
North America, South America and Australia	87.5 ~ 107.9 MHz	± 200 kHz
Asia and Europe	87.5 ~ 108.0 MHz	± 100 kHz
Japan	76.0 ~ 95.0 MHz	± 100 kHz

# 14. TROUBLESHOOTING

Please visit [www.smarthjc.com](http://www.smarthjc.com) for more troubleshooting information.

- Customer Support: [www.smarthjc.com](http://www.smarthjc.com)

## 14.1 Fault Reset

When the headset is not working properly, you can easily reset the unit:

1. Locate the **Pinhole Fault Reset Button** next to the DC Power Charging & Firmware Upgrade Port.
2. Gently insert a paper clip into the hole and press the **Pinhole Fault Reset Button** with light pressure.

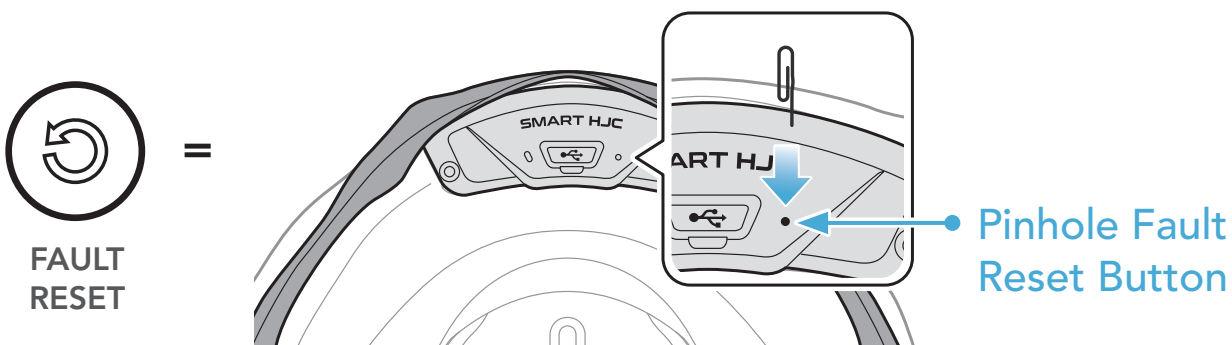

3. The headset will shut down.





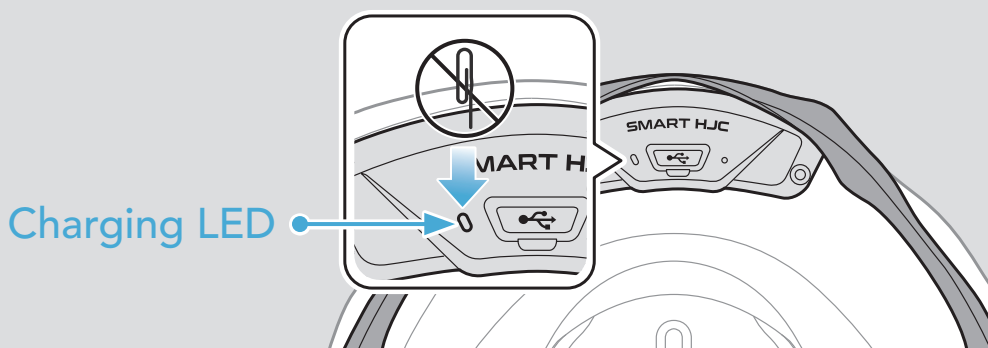







### Note:

- **Fault Reset** will not restore the headset to factory default settings.
- The charging LED is not the **Pinhole Fault Reset Button**. Do not press it.



## 14.2 Factory Reset

To erase all of your settings and start fresh, the headset can be restored to factory default settings using the **Factory Reset** feature.

1.  =   →  "Configuration menu"
2.  =   →  "Factory reset"
3.  =   →  "Headset reset, good-bye"