

# SMART HJC 21B

2<sup>nd</sup> GEN STANDARD MOTORCYCLE BLUETOOTH®  
COMMUNICATION SYSTEM FOR HJC HELMETS

**HD** SPEAKERS

## USER'S GUIDE

Version 1.1.0

ENGLISH

# TABLE OF CONTENTS

<b>1.</b>	<b>ABOUT THE SMART HJC 21B</b>	<b>5</b>
1.1	Product Features	5
1.2	Product Details	6
1.3	Package Contents	7
<b>2.</b>	<b>INSTALLING THE HEADSET ON YOUR HELMET</b>	<b>8</b>
2.1	Helmet Installation	8
2.1.1	Modular Chin Bar / Open & Full Face Visor Opening	8
2.1.2	Helmet Module Cover Removing	8
2.1.3	Helmet's Cheek Pad Take Off	9
2.1.4	Button Module Installation	9
2.1.5	Bluetooth Module Installation	10
2.1.6	Microphone Installation	11
2.1.7	Speaker Module Installation	14
2.1.8	Wire Arrangement	15
2.1.9	Cheek Pad Fasten Up	15
2.1.10	Modular Chin Bar / Open & Full Face Visor Closing	16
<b>3.</b>	<b>GETTING STARTED</b>	<b>17</b>
3.1	Downloadable Software	17
3.1.1	SMART HJC BT App	17
3.1.2	SMART HJC Device Manager	17
3.2	Charging	17
3.3	Legend	18
3.4	Powering On and Off	18
3.5	Checking the Battery Level	18
3.6	Volume Adjustment	19
<b>4.</b>	<b>PAIRING THE HEADSET WITH OTHER BLUETOOTH DEVICES</b>	<b>20</b>
4.1	Phone Pairing	20
4.1.1	Initially Pairing the SMART HJC 21B	20

4.1.2	Pairing When the SMART HJC 21B is Turned Off	21
4.1.3	Pairing When the SMART HJC 21B is Turned On	22
<b>4.2</b>	<b>Second Mobile Phone Pairing - Second Mobile Phone, GPS, and SR10</b>	<b>22</b>
<b>4.3</b>	<b>Advanced Selective Pairing: Hands-Free or A2DP Stereo</b>	<b>23</b>
4.3.1	Phone Selective Pairing - Hands-Free Profile	23
4.3.2	Media Selective Pairing - A2DP Profile	23
<b>4.4</b>	<b>GPS Pairing</b>	<b>24</b>
<b>5.</b>	<b>MOBILE PHONE USAGE</b>	<b>25</b>
<b>5.1</b>	<b>Making and Answering Calls</b>	<b>25</b>
<b>5.2</b>	<b>Speed Dialing</b>	<b>25</b>
5.2.1	Assigning Speed Dial Presets	25
5.2.2	Using Speed Dial Presets	25
<b>6.</b>	<b>STEREO MUSIC</b>	<b>27</b>
<b>6.1</b>	<b>Bluetooth Stereo Music</b>	<b>27</b>
<b>6.2</b>	<b>Music Sharing</b>	<b>27</b>
6.2.1	Bluetooth Intercom Music Sharing	27
<b>7.</b>	<b>BLUETOOTH INTERCOM</b>	<b>28</b>
<b>7.1</b>	<b>Intercom Pairing</b>	<b>28</b>
7.1.1	Using the Smart Intercom Pairing (SIP)	28
7.1.2	Using the Button	29
<b>7.2</b>	<b>Last-Come, First-Served</b>	<b>30</b>
<b>7.3</b>	<b>Two-Way Intercom</b>	<b>31</b>
<b>7.4</b>	<b>Multi-Way Intercom</b>	<b>32</b>
7.4.1	Starting a Three-Way Intercom Conference	32
7.4.2	Starting a Four-Way Intercom Conference	33
7.4.3	Ending Multi-Way Intercom	33
<b>7.5</b>	<b>Three-Way Conference Phone Call with Intercom Users</b>	<b>34</b>
<b>7.6</b>	<b>Group Intercom</b>	<b>35</b>

<b>8.</b>	<b>UNIVERSAL INTERCOM</b>	<b>36</b>
<hr/>		
8.1	Universal Intercom Pairing	36
8.2	Two-Way Universal Intercom	36
8.3	Multi-Way Universal Intercom	37
8.3.1	Three-Way Universal Intercom	37
8.3.2	Four-Way Universal Intercom	38
<b>9.</b>	<b>FUNCTION PRIORITY AND FIRMWARE UPGRADES</b>	<b>39</b>
<hr/>		
9.1	Function Priority	39
9.2	Firmware Upgrades	39
<b>10.</b>	<b>CONFIGURATION SETTING</b>	<b>40</b>
<hr/>		
10.1	Headset Configuration Menu	40
10.1.1	Delete All Pairings	41
10.1.2	Remote Control Pairing	41
10.2	Software Configuration Setting	41
10.2.1	Headset Language	41
10.2.2	Audio Equalizer (Default: Off)	42
10.2.3	VOX Phone (Default: Enable)	42
10.2.4	VOX Intercom (Default: Disable)	42
10.2.5	HD Intercom (Default: Enable)	43
10.2.6	HD Voice (Default: Enable)	43
10.2.7	Audio Multitasking™ (Default: Disable)	44
10.2.8	Background Volume (Default: Level 5)	45
10.2.9	Audio Source Priority (Default: Intercom)	45
10.2.10	Voice Prompt (Default: Enable)	45
10.2.11	Advanced Noise Control™ (Always On)	45
<b>11.</b>	<b>TROUBLESHOOTING</b>	<b>46</b>
<hr/>		
11.1	Fault Reset	46
11.2	Factory Reset	47

# 1. ABOUT THE SMART HJC 21B

## 1.1 Product Features

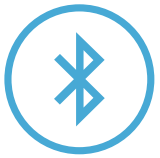

Bluetooth® 5.1



Intercom up to 1.6 km (1.0 mi)\*



Four-Way Intercom



Audio Multitasking™



Custom Helmet Fit

\* Intercom range will vary depending on obstacles (person, metal, wall, etc.) or electromagnetic environment.

## 1.2 Product Details

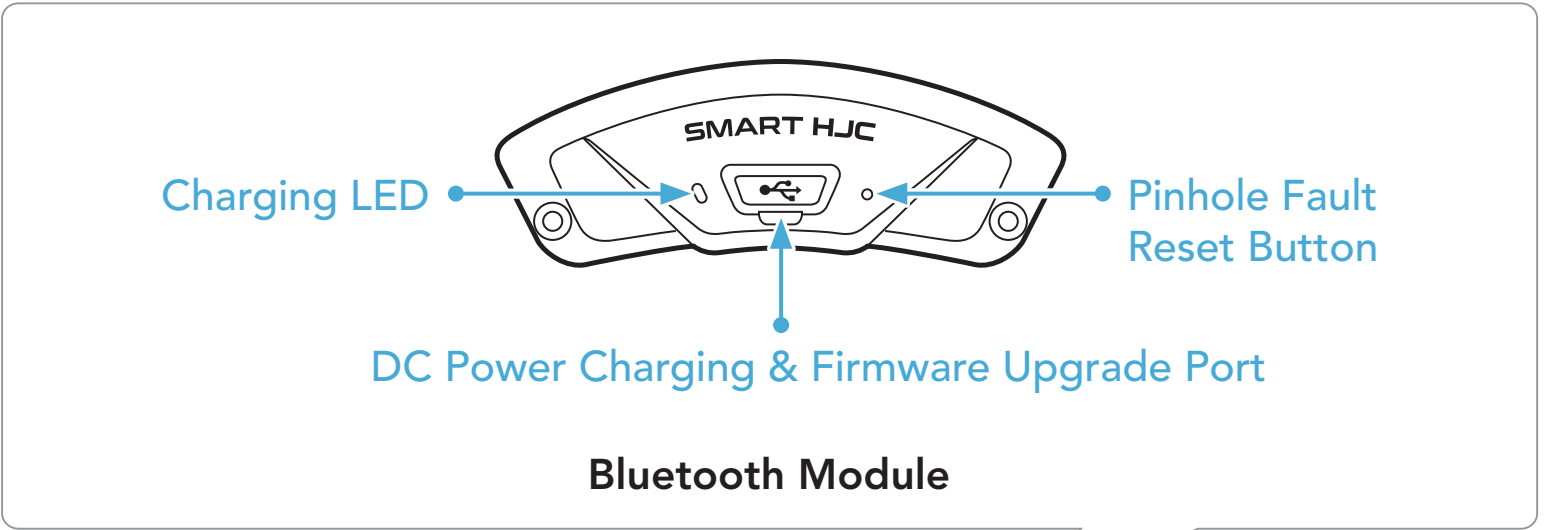

Charging LED

SMART HJC

Pinhole Fault Reset Button

DC Power Charging & Firmware Upgrade Port

Bluetooth Module

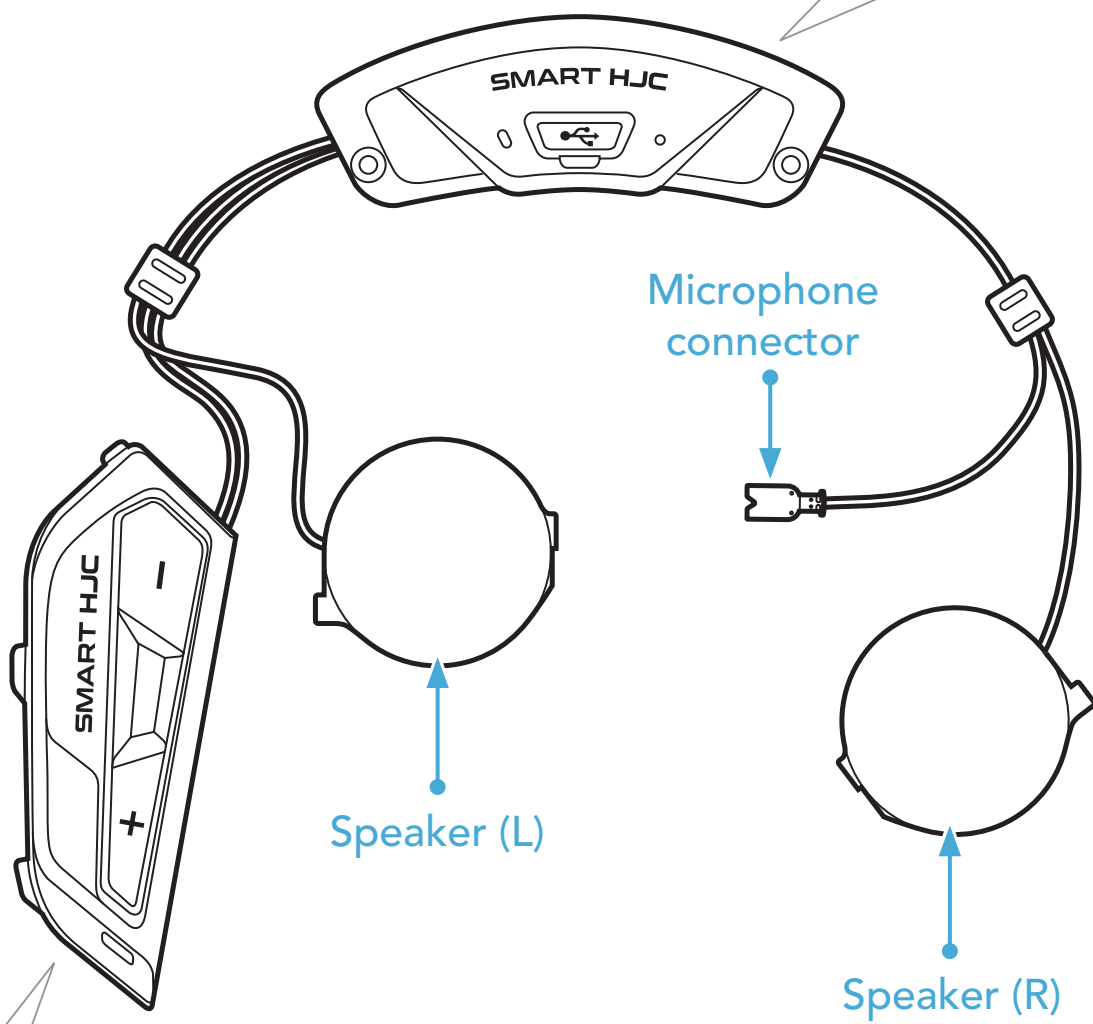

Microphone connector

Speaker (L)

Speaker (R)

SMART HJC

Status LED

SMART HJC

(-) Button

TAP Button

(+) Button

Button Module

## 1.3 Package Contents

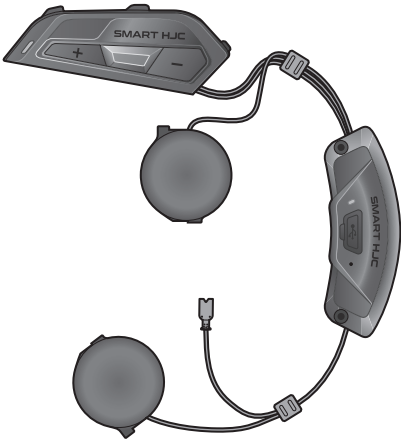

Headset Main Unit

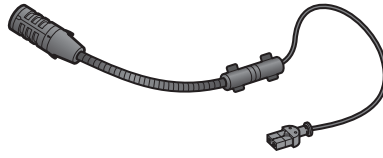

Wired Boom Microphone for Modular/Open Face Helmet

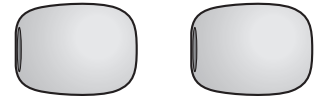

Microphone Sponges for Wired Boom Microphone

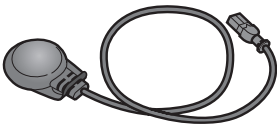

Wired Microphone for Full Face Helmet

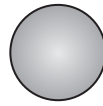

Hook and Loop Fastener for Wired Microphone



Screws

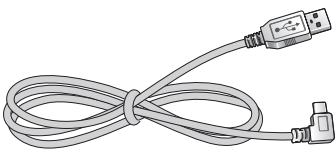

USB Power & Data Cable (USB-C)



Allen Wrench

## 2. INSTALLING THE HEADSET ON YOUR HELMET

SMART HJC 21B compatible **HJC helmets** can be found at [www.smarthjc.com](http://www.smarthjc.com)

### 2.1 Helmet Installation

To securely install the headset on the Modular helmet, Open Face helmet, or Full Face helmet, please follow this procedure.

#### 2.1.1 Modular Chin Bar / Open & Full Face Visor Opening

1. Lift the chin-bar of the modular helmet or the shield visor of the open face helmet completely.

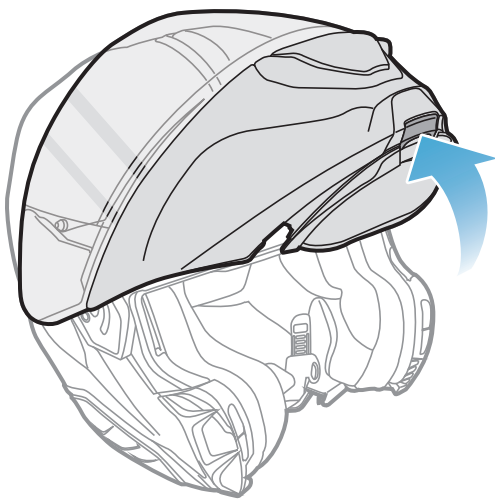

Modular Helmet

or

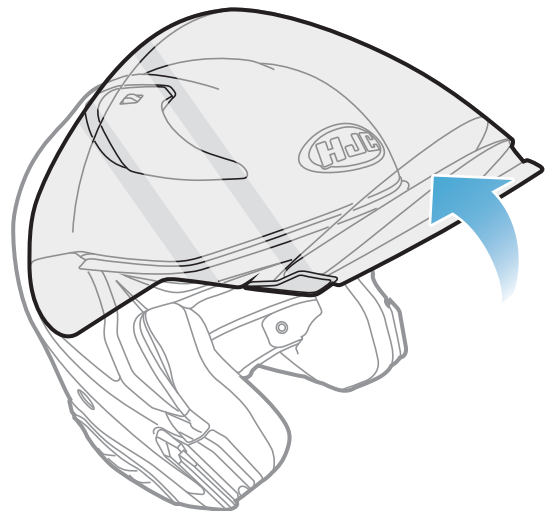

Open Face Helmet

#### 2.1.2 Helmet Module Cover Removing

1. By pushing the tab on the left side cover, push at an angle the left side cover to remove it.

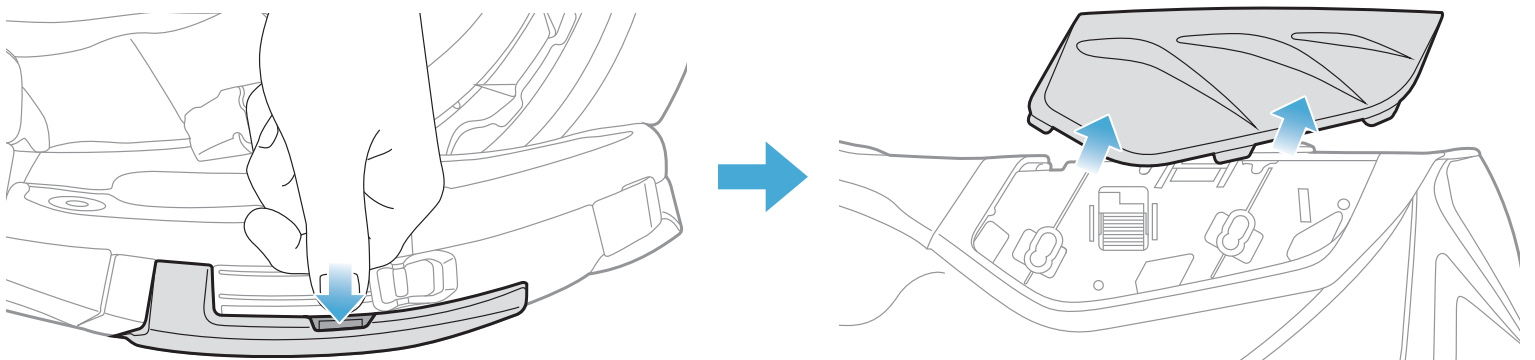



- Loosen the two short screws on the rear cover of the helmet with the Allen wrench that comes included, and then remove the cover.

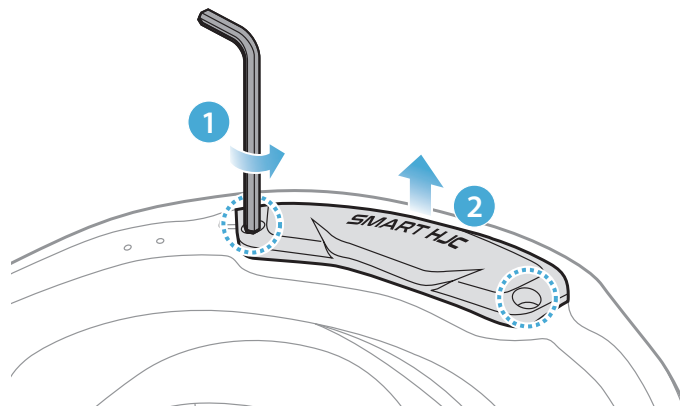

### 2.1.3 Helmet's Cheek Pad Take Off

- Detach the snap fasteners of the cheek pads and remove the cheek pads from the helmet.

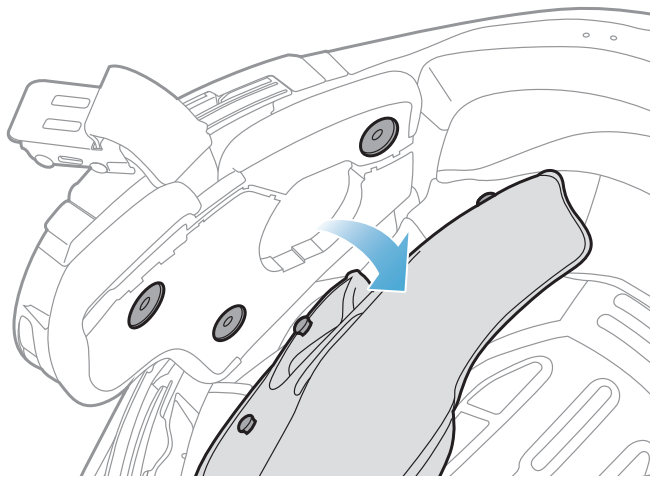

### 2.1.4 Button Module Installation

- Make sure that the grooved side of the Button Module fits the corresponding grooves. Then, slide the Button Module into the corresponding place until you hear a click sound.

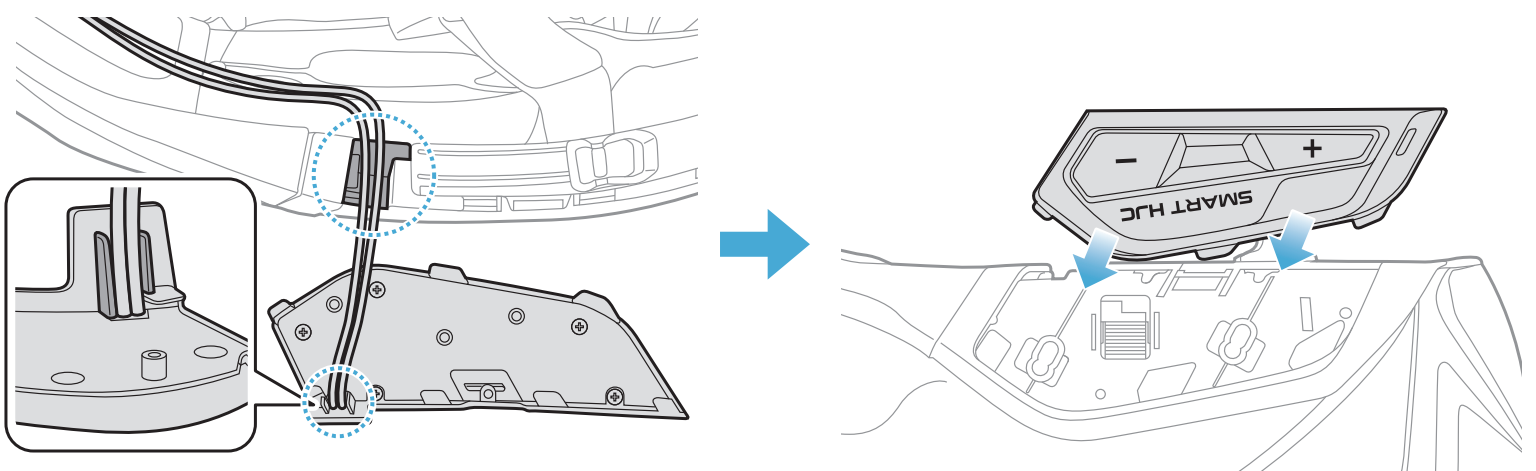

**Note:** Make sure the Button Module's wire is placed in the corresponding groove as shown in the illustration.

## 2.1.5 Bluetooth Module Installation

1. Facing the USB port on the Bluetooth Module toward the rear of the helmet, pull the rubber guard up and insert the Bluetooth Module into the slot.

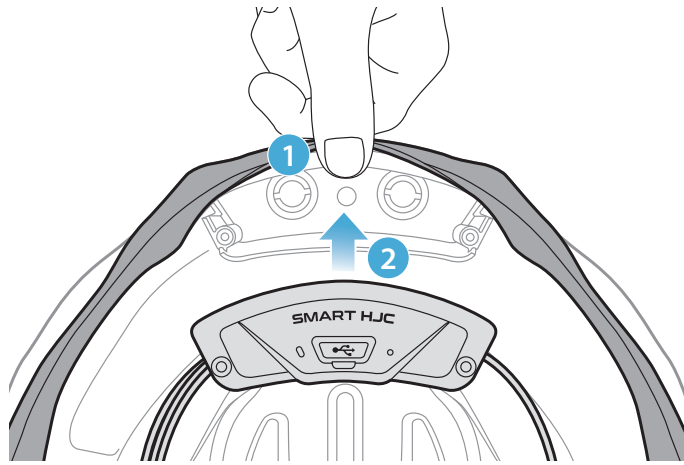

**Note:** Make sure the rubber guard of the helmet is not jammed between the Bluetooth Module and its slot.



2. To organize the Bluetooth Module's wire, pull back the rubber guard and place the wire in the groove as shown in the illustration.

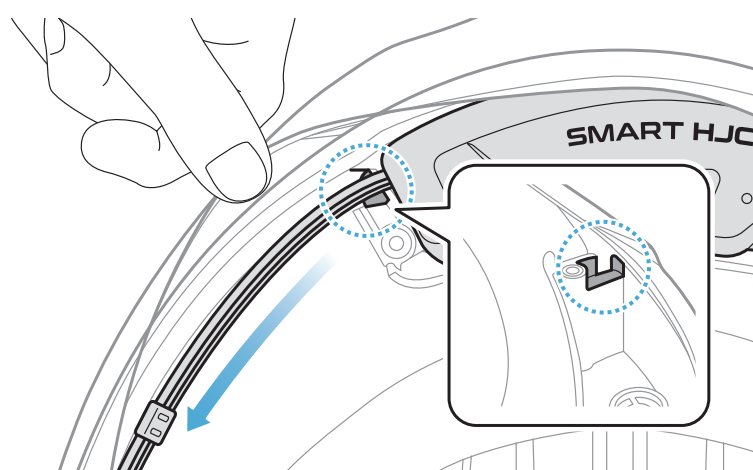

- Put the remaining wire into the gap under the helmet's rubber guard.

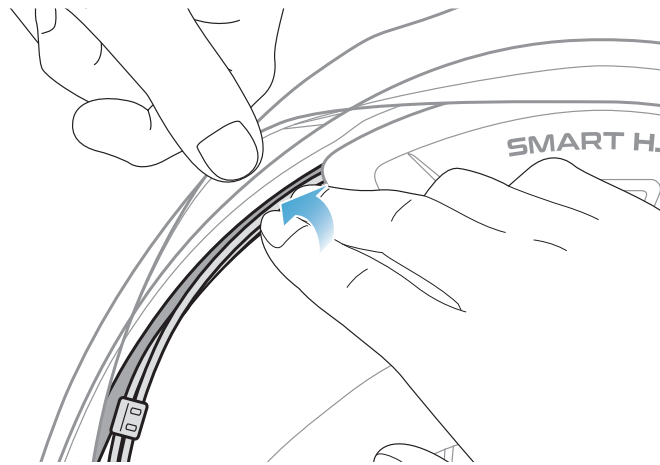

- Tighten the two long screws until the Bluetooth Module is fastened firmly to the helmet.

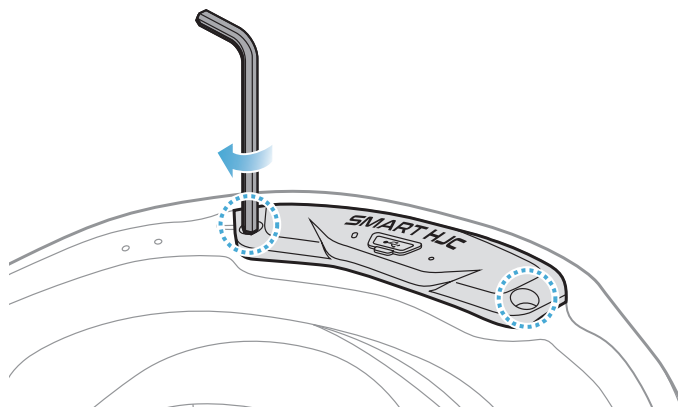

### 2.1.6 Microphone Installation

- Modular or Open Face Microphone Installation

- Insert the Wired Boom Microphone's long hook into the groove in the EPS of the helmet first and then insert the short hook.

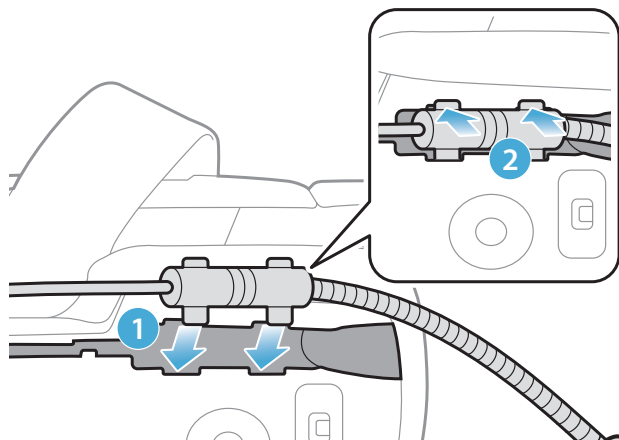

2. Place the microphone's wire in the groove and then place the remaining portion of microphone's wire into the speaker pocket for installing the speaker unit.

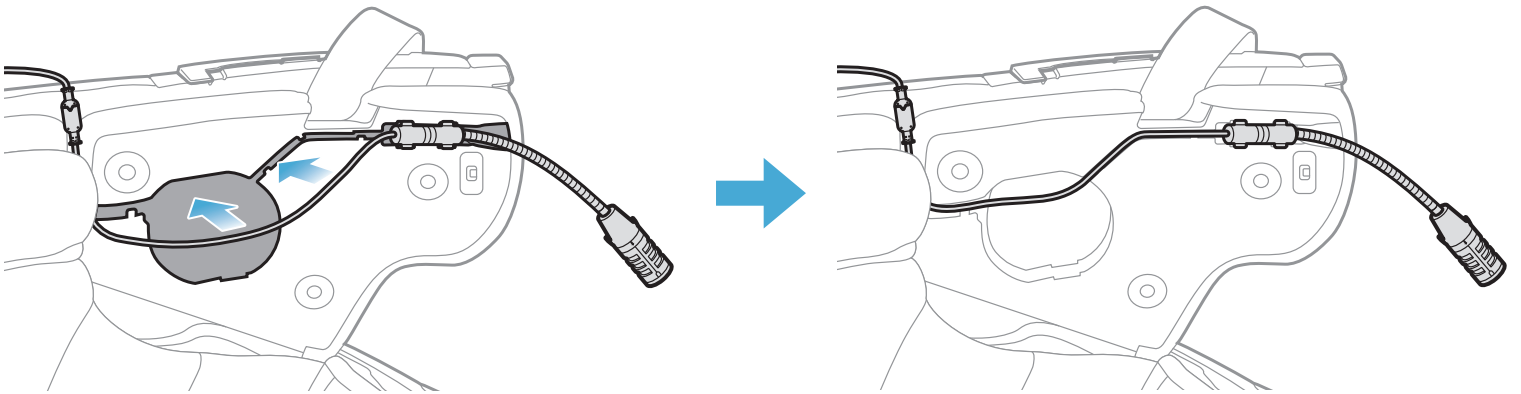

3. Align the arrows on the microphone wire and insert the microphone wire into the microphone connector.

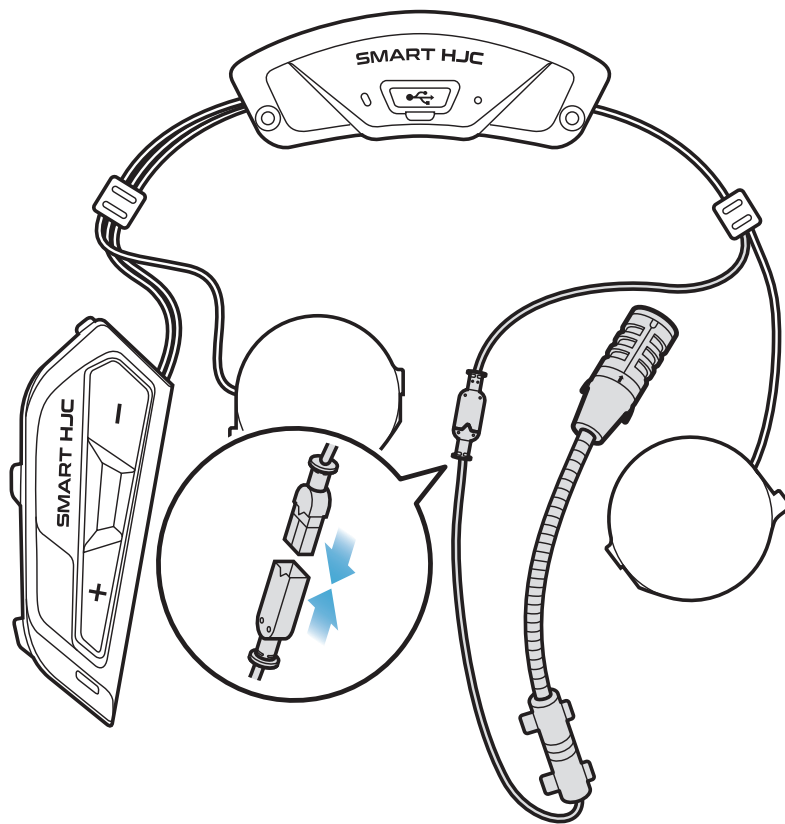

- Full Face Microphone Installation

1. Peel off the cover of the adhesive tape of the hook and loop fastener for the microphone and attach it to the inside of the helmet's chin guard.

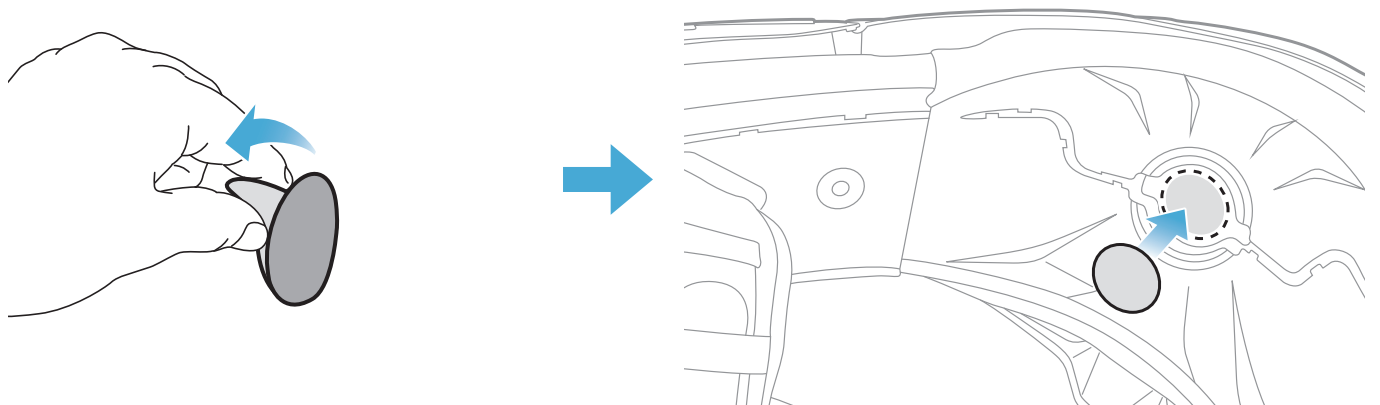

2. Attach the wired microphone to the hook and loop fastener.

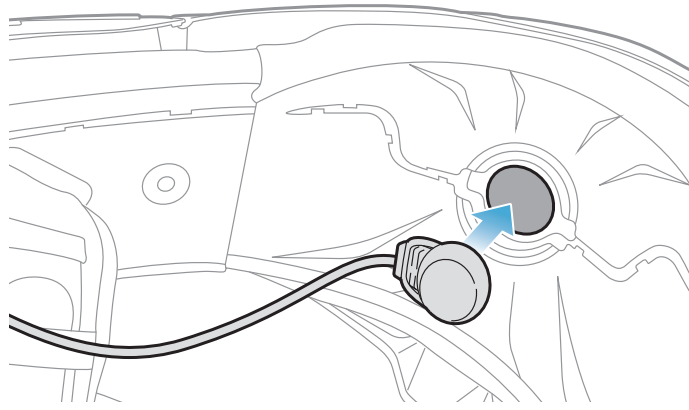

3. Place the microphone's cable in the groove and then place the remaining portion of the microphone's wire in the speaker pocket for installing the speaker unit as shown in the illustration.

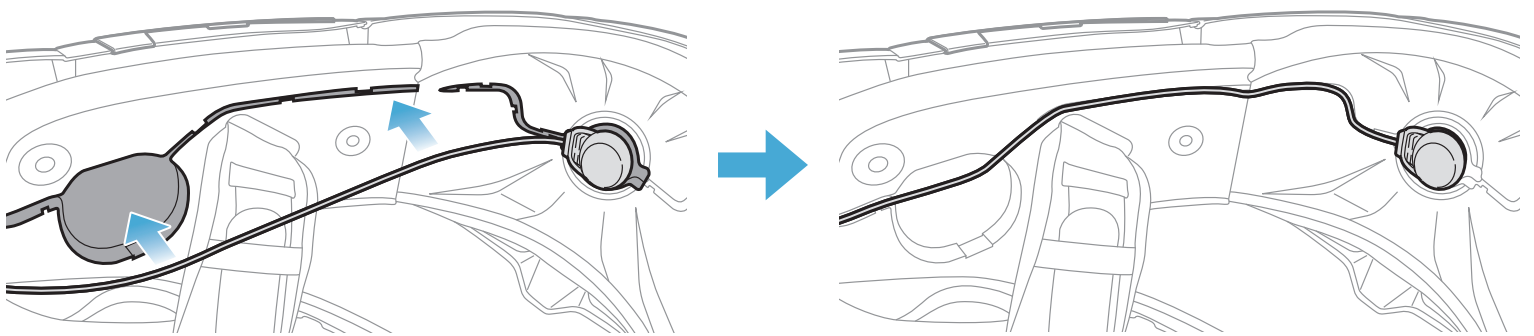

4. Align the arrows on the microphone wire and insert the microphone wire into the microphone connector.

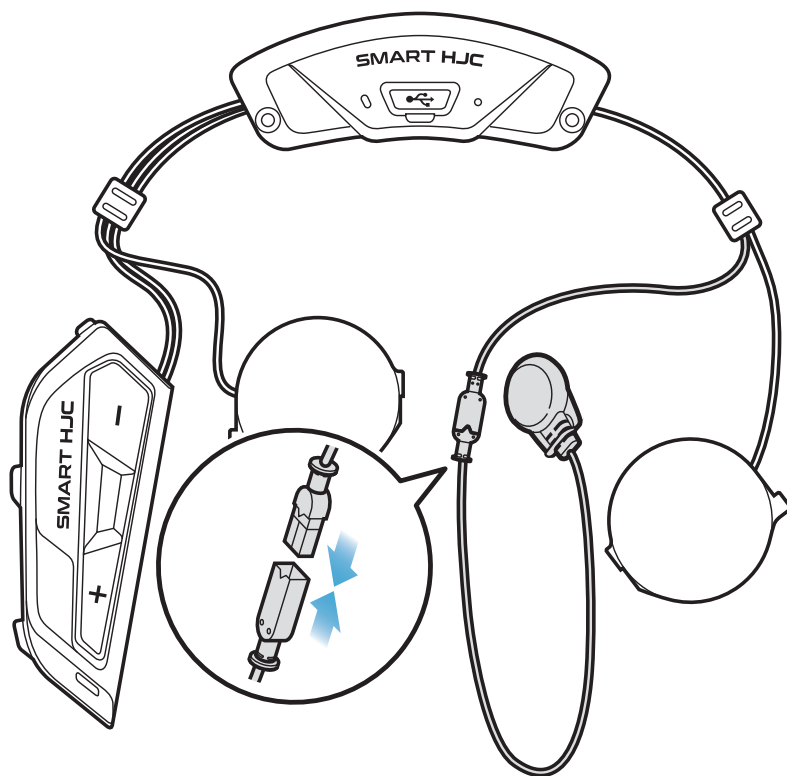

## 2.1.7 Speaker Module Installation

1. Insert the longer hook of the right speaker unit into the bottom hole of the speaker pocket. Then, insert the shorter hook of the right speaker unit into the top hole of the speaker pocket.

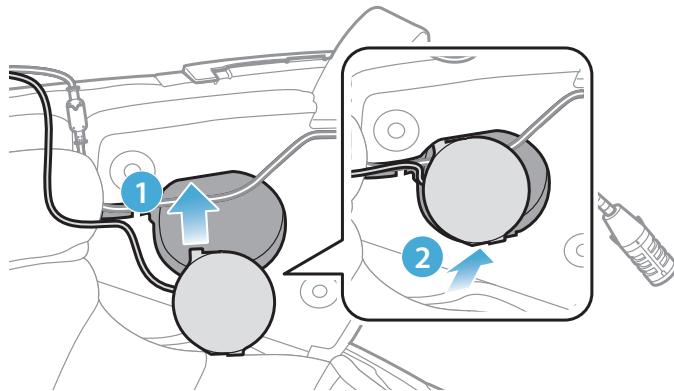

**[Make sure that the Microphone wire is not pressured by the speaker unit when installed]**

2. Then, push the top of the unit so that it fixes onto the helmet's speaker pocket.

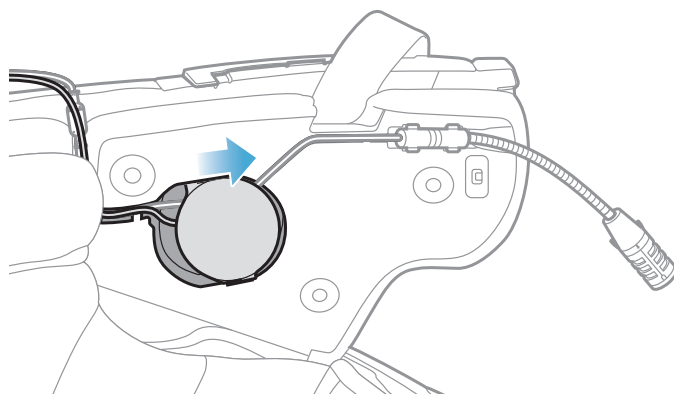

**[Once installed, the position of the speaker unit can be adjusted to rider's ear position]**

3. Repeat the process on the other side to install the left speaker unit.

### **Note:**

#### **Removing the Speaker Unit**

To remove the speaker unit, insert the **Allen Wrench** into the upper shorter hook area then pull out the speaker unit.

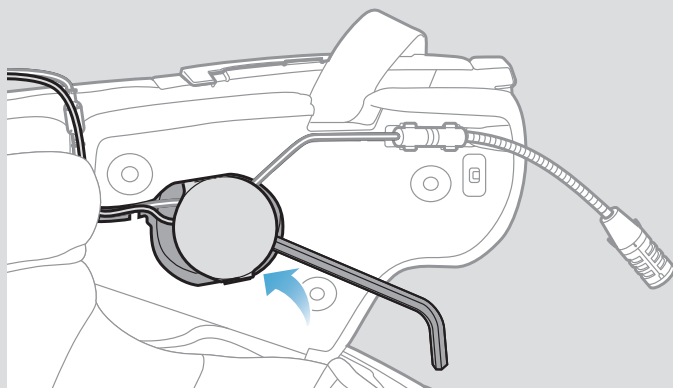

## 2.1.8 Wire Arrangement

1. Put the bundle of the wires in the gap under the helmet's rubber guard and organize the remaining wire in the shape of an arch as shown in the illustration.

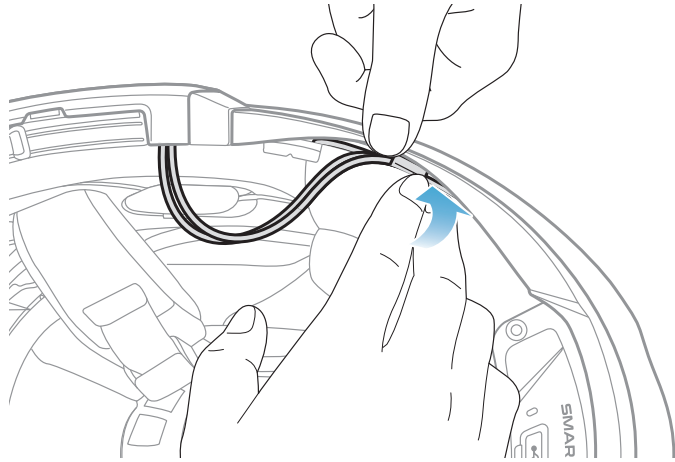

2. Align the remaining wire and groove of the cheek pad, and insert the cheek pad beginning with its rear as shown in the illustration.

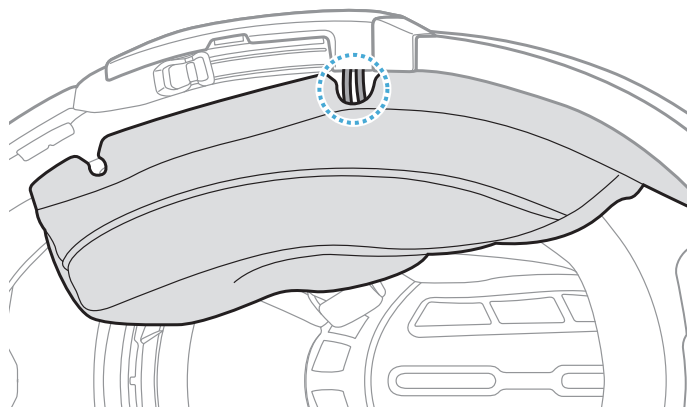

## 2.1.9 Cheek Pad Fasten Up

1. Reattach the cheek pads, beginning with its rear, and click the snap fasteners.

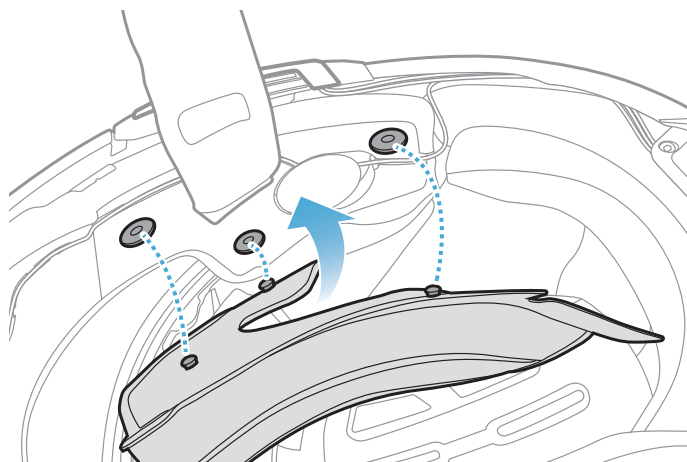

### 2.1.10 Modular Chin Bar / Open & Full Face Visor Closing

1. Lower the chin-bar of the modular helmet or the shield visor of the open face helmet completely.

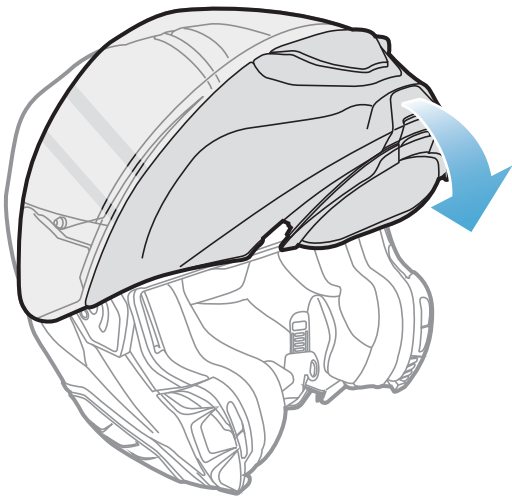

**Modular Helmet**

or

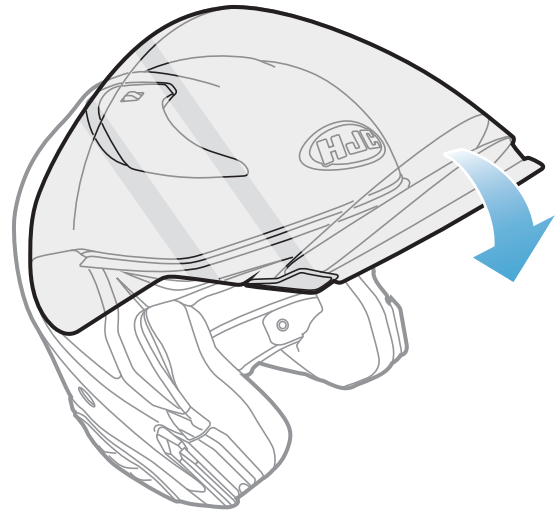

**Open Face Helmet**

2. Make sure that the Wired Boom Microphone is a proper distance from your mouth when you wear the helmet.

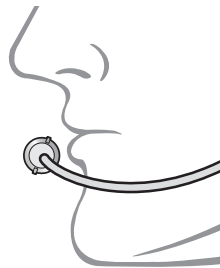



# 3. GETTING STARTED

## 3.1 Downloadable Software

### 3.1.1 SMART HJC BT App

By simply pairing your phone with your headset, you can use the **SMART HJC BT App** for quicker, easier set up and management.



- Download the **SMART HJC BT App** on [Google Play Store](#) or [App Store](#).

### 3.1.2 SMART HJC Device Manager

The **SMART HJC Device Manager** allows you to upgrade firmware and configure settings directly from your PC.



- Download the **SMART HJC Device Manager** at [www.smarthjc.com](http://www.smarthjc.com)

## 3.2 Charging

### Charging the headset

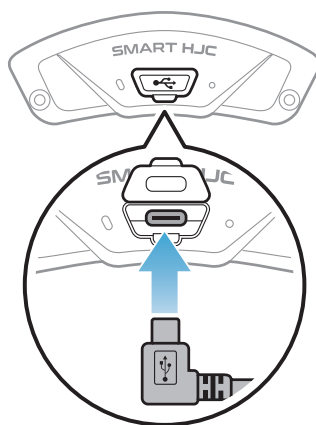

Depending upon the charging method, the headset will be fully charged in about 2.5 hours.

**Note:**

- Please make sure to take off your headset-installed helmet while charging. The headset automatically turns off during charging.
- Any 3rd party USB charger can be used with HJC products if the charger is approved by either the FCC, CE, IC, KC, or other locally approved agencies.
- Use of a non-approved charger may cause fire, explosion, leakage, and other hazards which may also reduce the life time or performance of the battery.
- The **headset** is compatible with 5 V input USB-charged devices only.

### 3.3 Legend

 Tap button the specified number of times

 Press and Hold button for the specified amount of time

 "Hello"

Audible prompt

### 3.4 Powering On and Off

**Powering On**

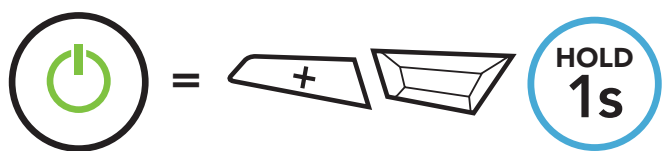

**Powering Off**

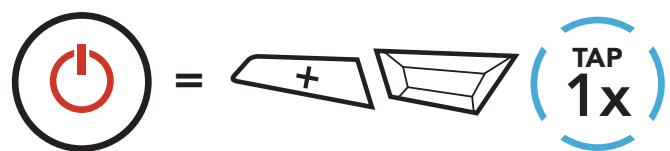

### 3.5 Checking the Battery Level

Instructions are for when powering the headset on.

**Powering On**

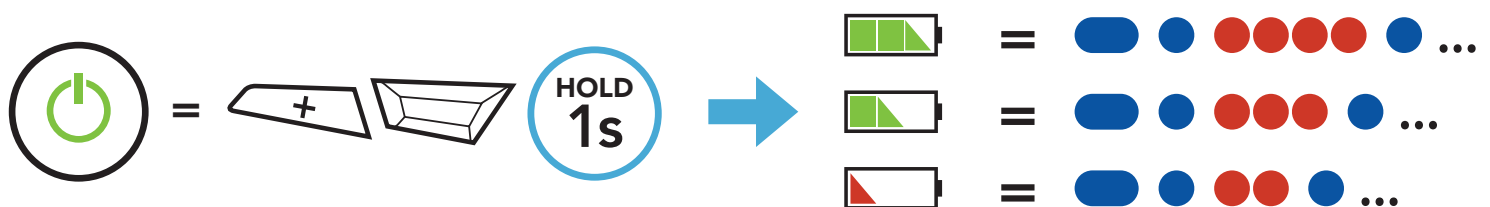

**Note:** When the battery is low while in use, you will hear a voice prompt saying **"Low battery"**.

## 3.6 Volume Adjustment

You can raise or lower the volume by tapping the **(+) Button** or the **(-) Button**. Volume is set and maintained independently at different levels for each audio source (i.e., phone, intercom), even when the headset is rebooted.

### Volume Up

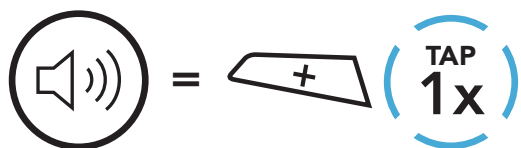

### Volume Down

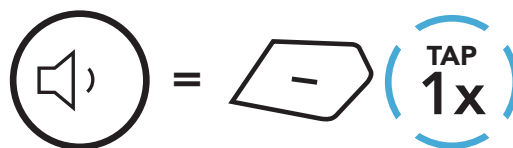

## 4. PAIRING THE HEADSET WITH OTHER BLUETOOTH DEVICES

When using the headset with other Bluetooth devices for the first time, they will need to be “paired.” This enables them to recognize and communicate with one another whenever they are within range.

The headset can pair with multiple Bluetooth devices such as a mobile phone, GPS, MP3 player or Sena SR10 Two-Way Radio Adapter via **Mobile Phone Pairing, Second Mobile Phone Pairing and GPS Pairing**. The headset can also be paired with up to three other SMART HJC headsets.

Pairs with up to Three SMART HJC headsets



Also Pairs with:

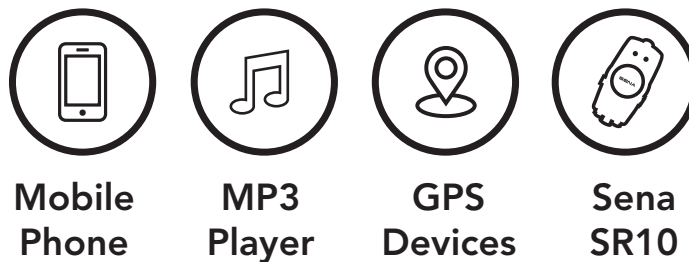

### 4.1 Phone Pairing

There are three ways to pair the phone.

#### 4.1.1 Initially Pairing the SMART HJC 21B

The headset will automatically enter the phone pairing mode when you initially turn on the headset or in the following situation:

- Rebooting after executing **Factory Reset**; or
- Rebooting after executing **Delete All Pairings**.

1. Press and hold the **TAP Button** and the **(+) Button** for **1 second**.



2. Select **SMART HJC 21B** in the list of Bluetooth devices detected. If your mobile phone asks for a PIN, enter 0000.



**Note:**

- The phone pairing mode lasts for **3 minutes**.
- To cancel phone pairing, tap the **TAP Button**.

### 4.1.2 Pairing When the SMART HJC 21B is Turned Off

1. While the headset is off, press and hold the **TAP Button** and the **(+) Button** until the LED flashes red and blue alternately and you hear a voice prompt, **"Phone pairing"**.



2. Select **SMART HJC 21B** in the list of Bluetooth devices detected. If your mobile phone asks for a PIN, enter 0000.



### 4.1.3 Pairing When the SMART HJC 21B is Turned On

1. While the headset is on, press and hold the **TAP Button** for **10 seconds**.



2. Tap the **(+) Button**.



3. Select **SMART HJC 21B** in the list of Bluetooth devices detected. If your mobile phone asks for a PIN, enter 0000.

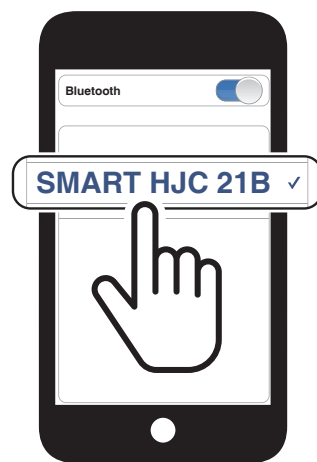

### 4.2 Second Mobile Phone Pairing - Second Mobile Phone, GPS, and SR10

1. Press and hold the **TAP Button** for **10 seconds**.



2. Double tap the **(+) Button**.



3. Select **SMART HJC 21B** in the list of Bluetooth devices detected. If your Bluetooth device asks for a PIN, enter 0000.

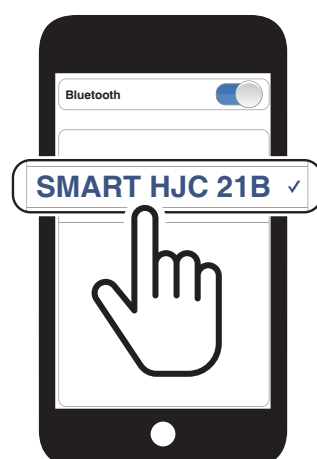

## 4.3 Advanced Selective Pairing: Hands-Free or A2DP Stereo

**Phone Pairing** allows the headset to establish two Bluetooth profiles: **Hands-Free** or **A2DP Stereo**. **Advanced Selective Pairing** allows the headset to separate the profiles to enable connection with two devices.

### 4.3.1 Phone Selective Pairing - Hands-Free Profile

1. Press and hold the **TAP Button** for **10 seconds**.



2. Tap the **(+) Button** 3 times.

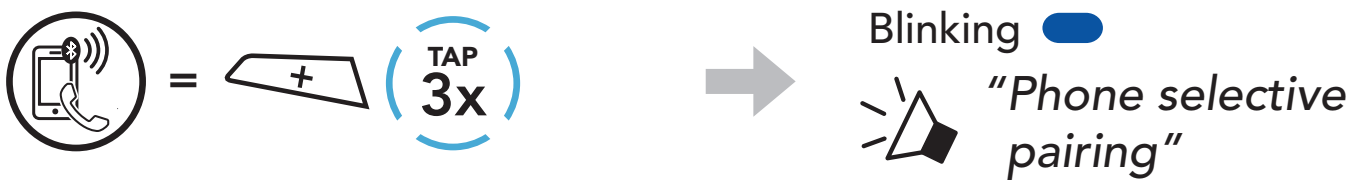

3. Select **SMART HJC 21B** in the list of Bluetooth devices detected. If your mobile phone asks for a PIN, enter 0000.



### 4.3.2 Media Selective Pairing - A2DP Profile

1. Press and hold the **TAP Button** for **10 seconds**.



2. Tap the **(+) Button** 4 times.

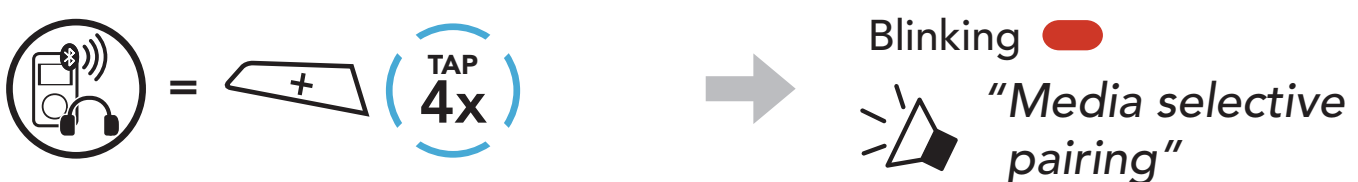

3. Select **SMART HJC 21B** in the list of Bluetooth devices detected. If your mobile phone asks for a PIN, enter 0000.



## 4.4 GPS Pairing

1. Press and hold the **TAP Button** for **10 seconds**.



2. Tap the **(+) Button** **5 times**.



3. Select **SMART HJC 21B** in the list of devices detected. If your Bluetooth device asks for a PIN, enter 0000.



**Note:** If you pair your GPS device via GPS Pairing, its instruction will not interrupt your Intercom conversations, but overlay with them. Bluetooth intercom conversations will be interrupted by GPS instructions.



# 5. MOBILE PHONE USAGE

## 5.1 Making and Answering Calls

### Answer a Call

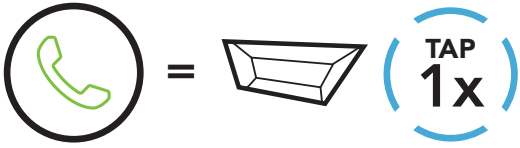

### End a Call

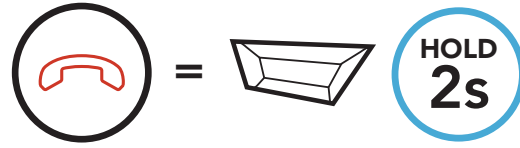

### Reject a Call

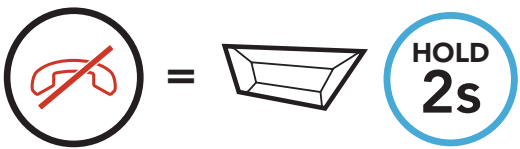

### Voice Dial



## 5.2 Speed Dialing

### 5.2.1 Assigning Speed Dial Presets

**Speed Dial Presets** could be assigned through the **SMART HJC BT App**.

### 5.2.2 Using Speed Dial Presets

1. Enter into the **Speed Dial** menu.



2. Navigate forward or backward through **Speed Dial Preset** numbers.

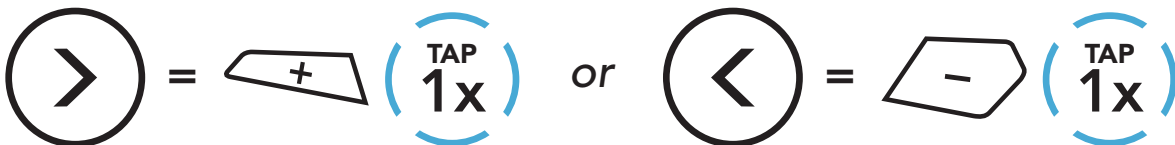

(1) Last number redial

(2) Speed dial 1

(3) Speed dial 2

(4) Speed dial 3

(5) Cancel

3. Call one of your **Speed Dial Presets** numbers.



4. Redial the last number called.

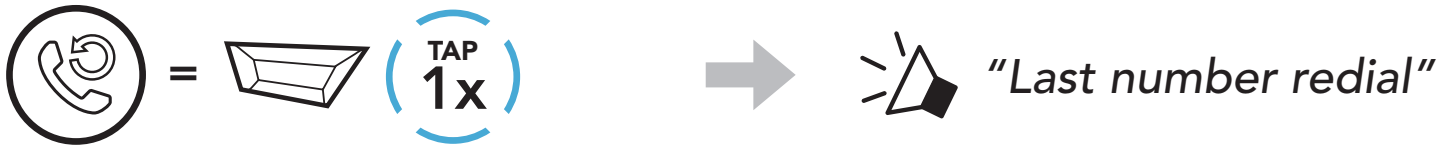

# 6. STEREO MUSIC

## 6.1 Bluetooth Stereo Music

### Play/Pause Music

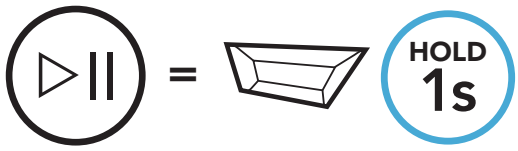

### Next Track

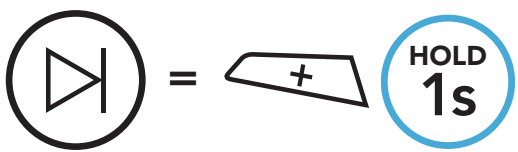

### Previous Track

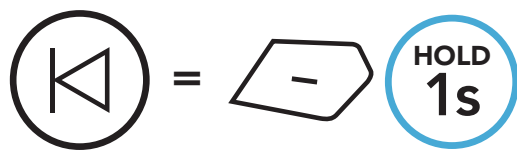

## 6.2 Music Sharing

You can start sharing music with one intercom friend using Bluetooth stereo music during a two-way intercom conversation.

### Note:

- Both you and your intercom friend can remotely control music playback such as track forward and track back.
- **Music sharing** will be paused when you are using your mobile phone or listening to GPS instructions.
- **Music sharing** will be terminated if the headset starts a multi-way intercom conference.
- When **Audio Multitasking** is enabled, if an intercom call is made when you are listening to music, **Music sharing** will not work.

### 6.2.1 Bluetooth Intercom Music Sharing

You can start sharing the music with one intercom friend of a two-way intercom conversation.

### Start/Terminate Sharing Music

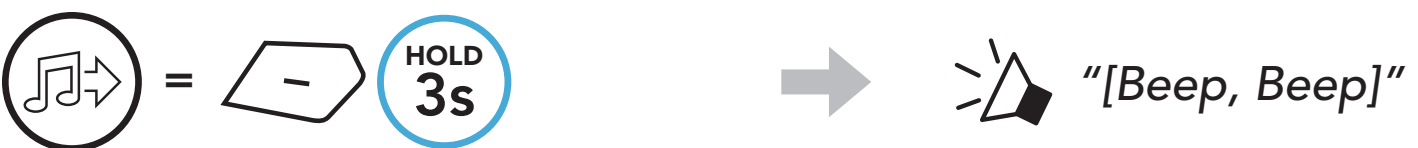

# 7. BLUETOOTH INTERCOM

Up to three other people can be paired with the headset for Bluetooth intercom conversations.

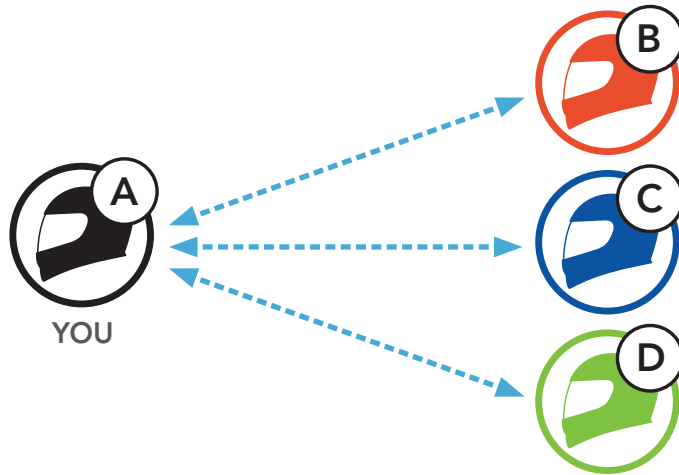



## 7.1 Intercom Pairing

There are two ways to pair the headset.

### 7.1.1 Using the Smart Intercom Pairing (SIP)

**SIP** allows you to quickly pair with your friends for intercom communication by scanning the QR code on the **SMART HJC BT App** without remembering the button operation.

1. Pair the mobile phone with the headset.
2. Open the **SMART HJC BT App** and tap  (**Smart Intercom Pairing Menu**).
3. Scan the **QR code** displayed on your friend (**B**)'s mobile phone.
  - Your friend (**B**) can display the QR code on the mobile phone by tapping  > **QR code** () on the **SMART HJC BT App**.

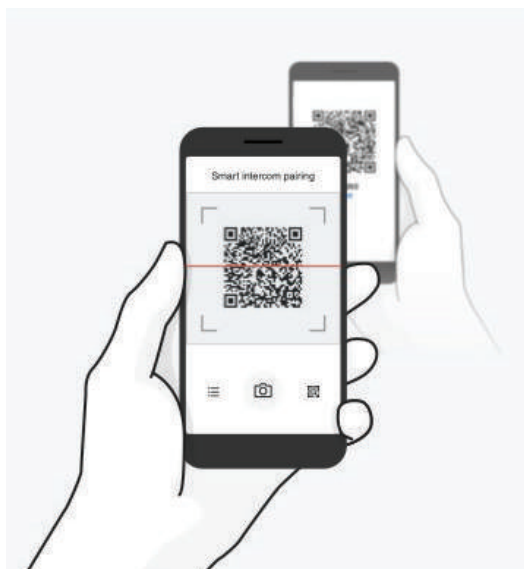

4. Tap **Save** and check that your friend **(B)** is paired with **you (A)** correctly.
5. Tap **Scan** (📷) and repeat steps 3-4 to pair with **Intercom Friends (C)** and **(D)**.

**Note:** The **Smart Intercom Pairing (SIP)** is not compatible with SMART HJC headsets that use **Bluetooth 3.0** or **below**.

## 7.1.2 Using the Button



1. **Each user** simultaneously presses and holds the **TAP Button** for **5 seconds** until users hear the voice prompt, **"Intercom Pairing."**

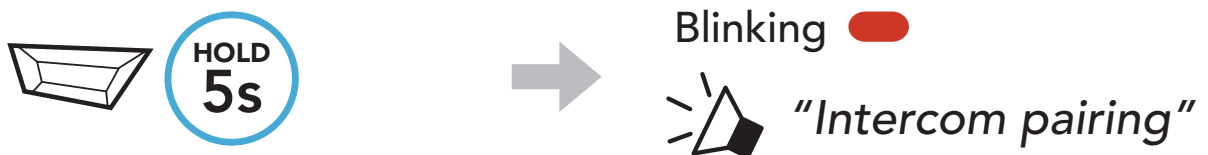

2. Tap the **TAP Button** on either headset.

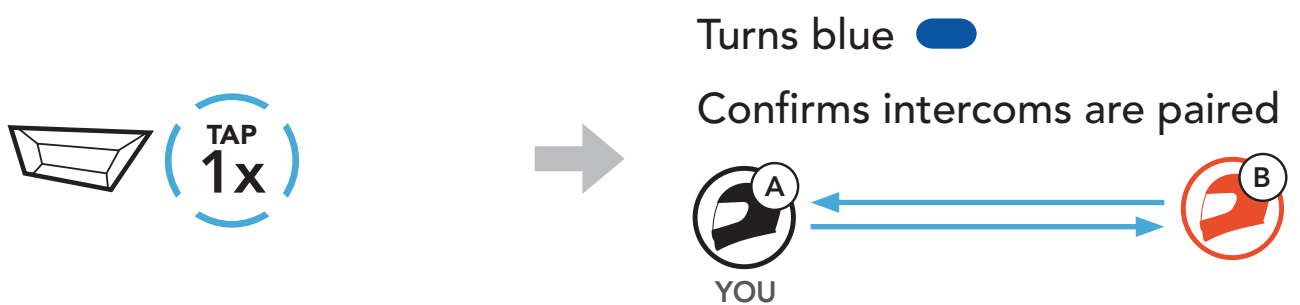

3. Repeat the steps above to pair with **other headsets (C and D)**.

## 7.2 Last-Come, First-Served

The intercom pairing queue is **Last-Come, First-Served**. If the headset has multiple paired headsets for intercom conversations, the last paired headset is set as the **First Intercom Friend**. For example, after the pairing procedures listed above, **headset (D)** is the **First Intercom Friend** of headset (A), **headset (C)** is the **Second Intercom Friend** of headset (A), and **headset (B)** is the **Third Intercom Friend** of headset (A).

### Intercom Pairing Order

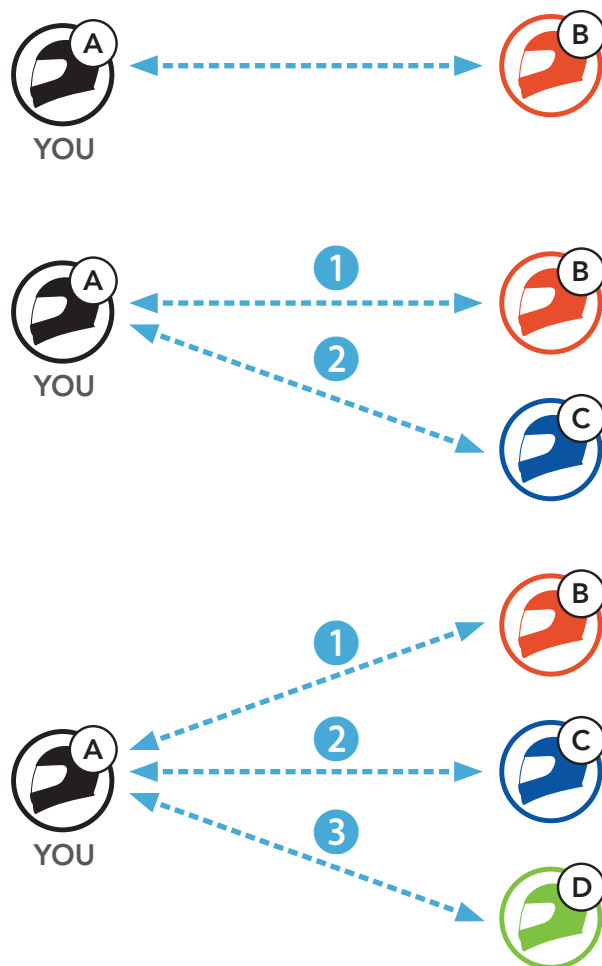

### Last-Come, First-Served

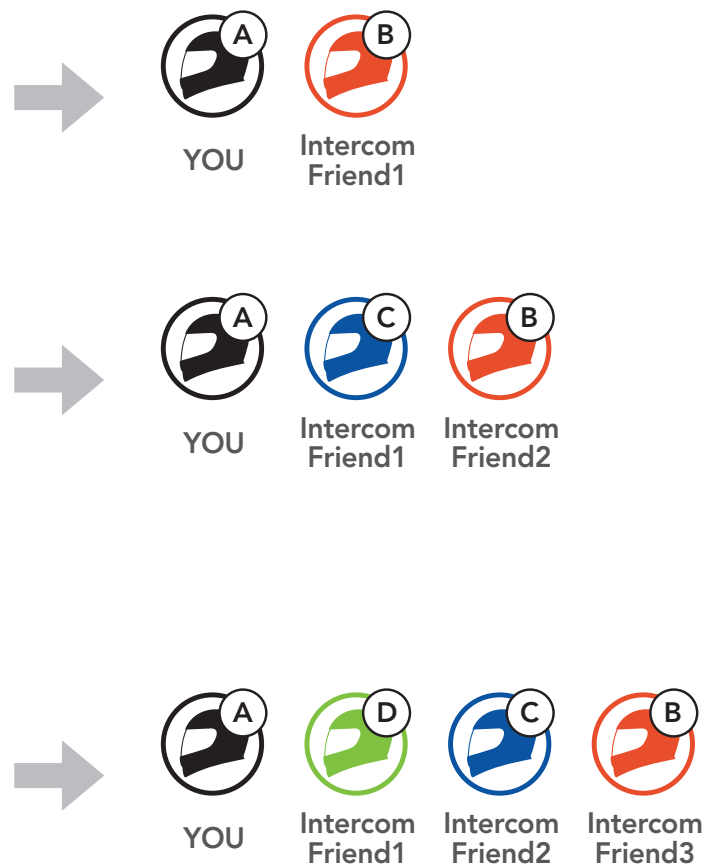

## 7.3 Two-Way Intercom

You can start or end an intercom conversation with an **Intercom Friend**.



### Start/End Conversation with the First Intercom Friend D

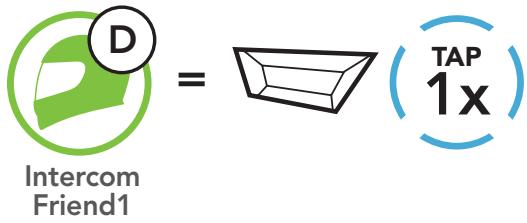

### Start/End Conversation with the Second Intercom Friend C

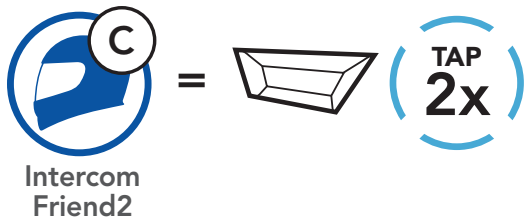

### Start/End Conversation with the Third Intercom Friend B

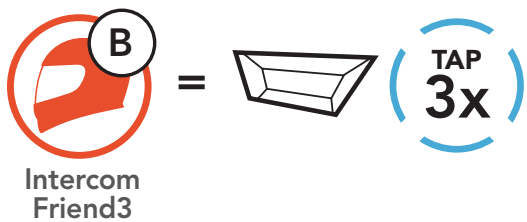

## 7.4 Multi-Way Intercom

**Multi-Way Intercom** enables conference-call-style conversations with up to **three Intercom Friends** at the same time. While **Multi-Way Intercom** is in progress, the mobile phone connection is temporarily disconnected. However, as soon as **Multi-Way Intercom** terminates, the mobile phone connection will be reestablished.

### 7.4.1 Starting a Three-Way Intercom Conference

**You (A)** can have a **Three-Way Intercom Conference** with two other **Intercom Friends (B and C)** by establishing two intercom connections simultaneously.

- You (A)** need to be paired with two other **Intercom Friends (B and C)** for the **Three-Way Intercom Conference**.



- Start an intercom conversation with the **First Intercom Friend (C)** by tapping the **TAP Button**.



- You (A)** can call the **Second Intercom Friend (B)** by double tapping the **TAP Button**, or the **Second Intercom Friend (B)** may join the intercom by making an intercom call to **you (A)**.



- Now **you (A)** and **two Intercom Friends (B and C)** are having a **Three-Way Intercom Conference**.





## 7.4.2 Starting a Four-Way Intercom Conference

With **three Intercom Friends** connected, a new participant (**D**) can make it a **Four-Way Intercom Conference** by making an intercom call to either (**B**) or (**C**).

1. **Intercom friend (B)** needs to be paired with a **new participant (D)**.

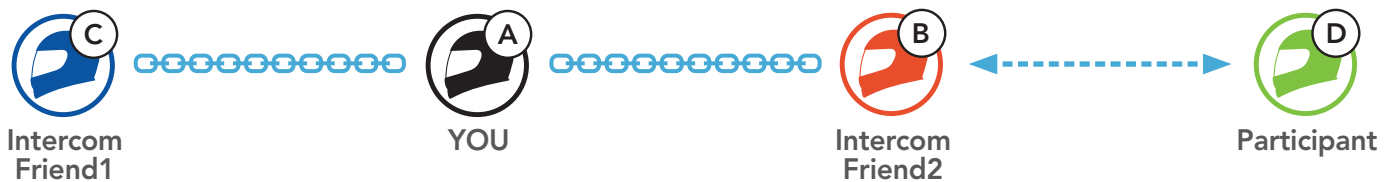

2. **Intercom friend (B)** can call a **new participant (D)** by tapping the **TAP Button**, or a **new participant (D)** may join the intercom by making an intercom call to **Intercom friend (B)**.

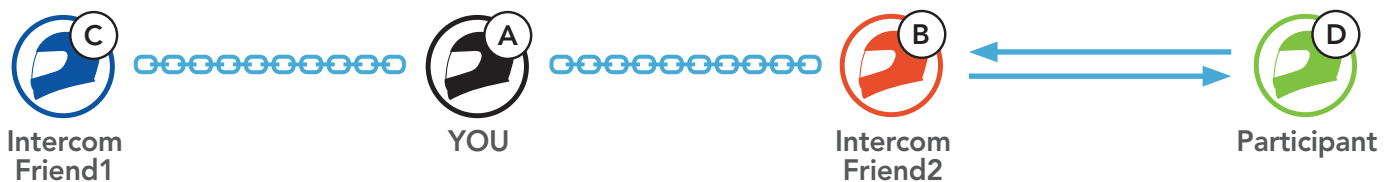

3. Now **you (A)**, **two Intercom Friends (B and C)**, and a **new participant (D)** are having a **Four-Way Intercom Conference**.

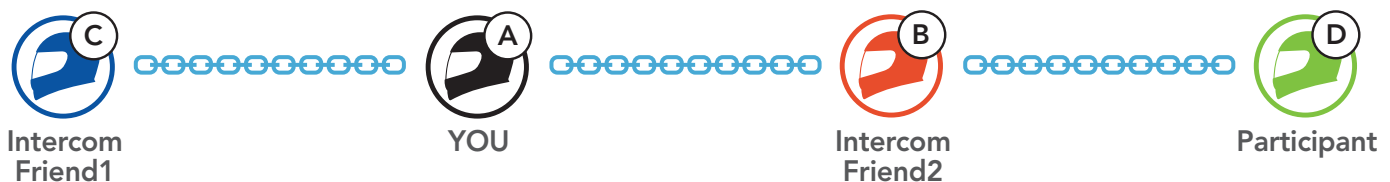

## 7.4.3 Ending Multi-Way Intercom

You can completely terminate the conference intercom or just disconnect an intercom connection with one of your active **Intercom Friends**.

### Terminate All Intercom Connections

- Press and hold the **TAP Button** for **3 seconds**.

### Disconnect the Intercom Connection with One of the Intercom Friends

- Disconnect (C): Tap the **TAP Button**.
- Disconnect (B) & (D): Double tap the **TAP Button**.

**Note:** When you disconnect the **second friend (B)**, you will be disconnected with the **third participant (D)** as well. This is because the **third participant (D)** is connected with you via the **second friend (B)**.

## 7.5 Three-Way Conference Phone Call with Intercom Users

You can have a **Three-Way Conference Phone Call** by adding an **Intercom Friend** to the mobile phone conversation.

1. During a mobile phone call, tap the **TAP Button once, twice, or three times** to invite one of your **Intercom Friends** to the conversation.

### Invite an Intercom Friend into Phone Conference

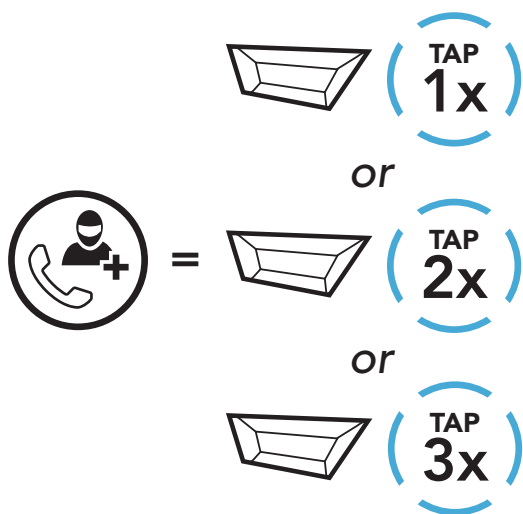

2. To disconnect the intercom during a conference phone call, tap the **TAP Button once, twice, or three times**.

### Disconnect the Intercom Friend from Conference

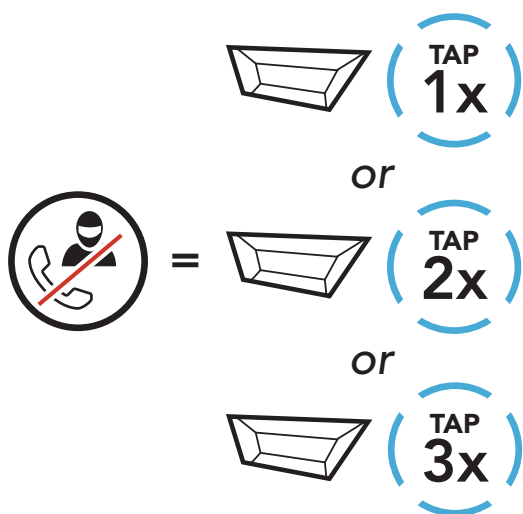

3. To disconnect the mobile phone call during a conference phone call, press and hold the **TAP Button for 2 seconds**.

### End Phone Call from Conference

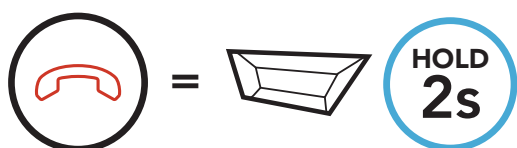

**Note:** When you have an incoming intercom call during a mobile phone call, you will hear high tone double beeps.

## 7.6 Group Intercom

**Group Intercom** allows you to instantly create a **Multi-Way Conference Intercom** with three of the most recently paired headsets.

### To Start the Group Intercom

1. Go through intercom pairing with up to three headsets you want to have **Group Intercom** with.

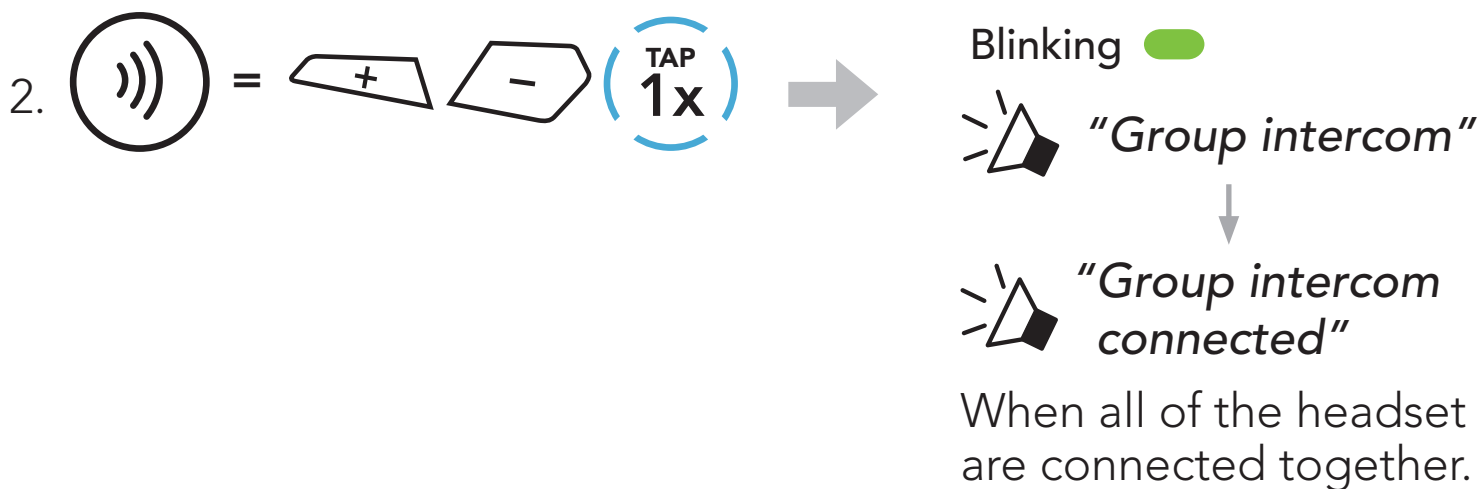









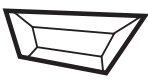

### Terminate Group Intercom



## 8. UNIVERSAL INTERCOM

**Universal Intercom** allows you to have intercom conversations with users of non-SMART HJC Bluetooth headsets. Non-SMART HJC Bluetooth headset can be connected to the SMART HJC headset if they support the **Bluetooth Hands-Free Profile (HFP)**. You can pair the headset with only one non-SMART HJC headset at a time. The intercom distance depends on the performance of the headset to which it's connected. When a non-SMART HJC headset is paired with the headset while another Bluetooth device is paired via **Second Mobile Phone Pairing**, it will be disconnected.

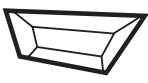
### 8.1 Universal Intercom Pairing

1.  =   →  "Configuration menu"
2.  =   →  "Universal intercom pairing"
3.  =   → Enter into **Universal Intercom Pairing** mode.

4. Put the non-SMART HJC headset in Hands-free Pairing Mode. The headset will automatically pair with a non-SMART HJC Bluetooth headset.

### 8.2 Two-Way Universal Intercom

You can initiate the **Universal Intercom** connection with non-SMART HJC Bluetooth headsets using the same intercom connection method as you would between other SMART HJC headsets.

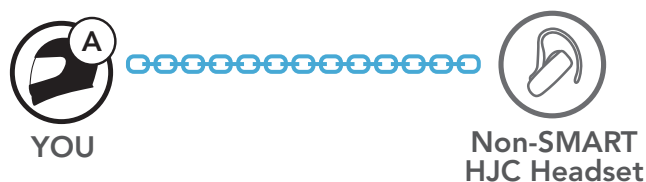

You may start/end a **Two-Way Universal Intercom** using the same way as you do in a normal **Two-Way Intercom**. Please refer to **Section 7.3: "Two-Way Intercom"**.

## 8.3 Multi-Way Universal Intercom

You can have **Multi-Way Intercom** communication with up to **three Intercom Friends** using non-SMART HJC headsets. Some non-SMART HJC headsets may not support **Multi-Way Universal Intercom**.

You may make the **Multi-Way Universal Intercom** call the same way as a normal four-way intercom call.

You may start/end a **Multi-Way Universal Intercom** using the same way as you do in a normal **Multi-Way Intercom**. Please refer to **Section 7.4: "Multi-Way Intercom"**.

### 8.3.1 Three-Way Universal Intercom

You may make a **Three-Way Universal Intercom** connection with two headsets and one non-SMART HJC Bluetooth headset. If the intercom connection is made, all headsets connected cannot use the mobile phone call function since the connection between the headset and the phone is disconnected temporarily. If you disconnect the intercom call, the mobile phone connection is made again automatically so that you can use a mobile phone call function.

1. **You (A)** need to be paired with a non-SMART HJC Bluetooth headset **(B)** and another headset **(C)** for the **Three-Way Conference Intercom**.

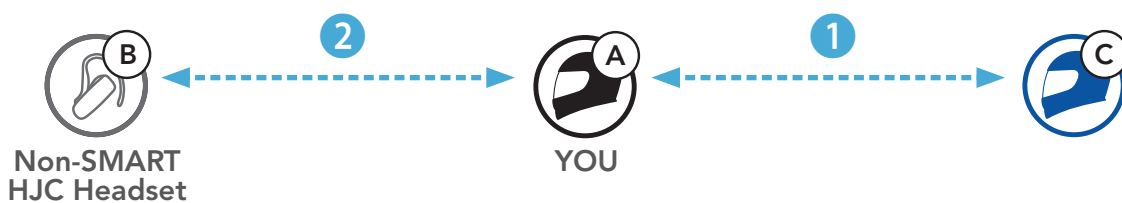

2. Start an intercom conversation with a non-SMART HJC Bluetooth headset **(B)** in your intercom group. For example, **you (A)** may start an intercom conversation with non-SMART HJC Bluetooth headset **(B)**. The non-SMART HJC Bluetooth headset **(B)** may also start an intercom call with **you (A)**.

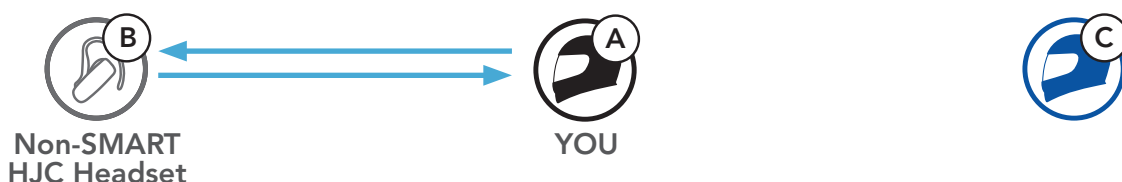

3. The other headset **(C)** may join the intercom by making an intercom call to **you (A)**.



4. Now **you (A)**, non-SMART HJC Bluetooth headset **(B)**, and the other headset **(C)** are having a **Three-Way Conference Intercom**.



### 8.3.2 Four-Way Universal Intercom

You may make the **Four-Way Universal Intercom** call the same way as a normal **Four-Way Intercom** call.

You may make a **Four-Way Universal Intercom** connection with a couple of different configurations,

- 1) two headsets and two non-SMART HJC Bluetooth headsets or
- 2) three headsets and one non-SMART HJC Bluetooth headset.

#### Four-Way Universal Intercom Case 1

- 1) **You (A)**, a non-SMART HJC Bluetooth headset **(B)**, another headset **(C)**, and a non-SMART HJC Bluetooth headset **(D)**.



#### Four-Way Universal Intercom Case 2

- 2) **You (A)**, a non-SMART HJC Bluetooth headset **(B)**, and **two other headsets (C and D)**.



# 9. FUNCTION PRIORITY AND FIRMWARE UPGRADES

## 9.1 Function Priority

The headset operates in the following order of priority:

- (highest) Mobile phone
- Intercom
- Music sharing via Bluetooth stereo music
- (lowest) Bluetooth stereo music

A lower priority function is always interrupted by a higher priority function.

**Note:** If you select music as the audio source priority, the order of priority will change as below:

- (highest) Mobile phone
- Bluetooth stereo music
- Intercom
- (lowest) Music sharing via Bluetooth stereo music

## 9.2 Firmware Upgrades

You can upgrade firmware using the **SMART HJC Device Manager**.

The **USB Power & Data Cable (USB-C)** must be connected to your **PC** to upgrade firmware using the **SMART HJC Device Manager**.

Please visit [www.smarthjc.com](http://www.smarthjc.com) to check for the latest software downloads.

[Click Here to Visit www.smarthjc.com](http://www.smarthjc.com)

# 10. CONFIGURATION SETTING

## 10.1 Headset Configuration Menu

### Accessing the Configuration Menu

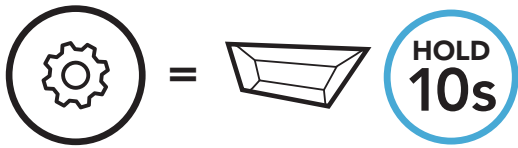

### Navigating Between Menu Options

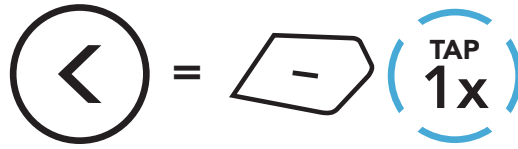
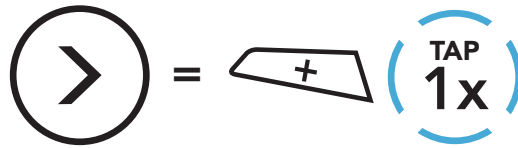

### Execute Menu Options

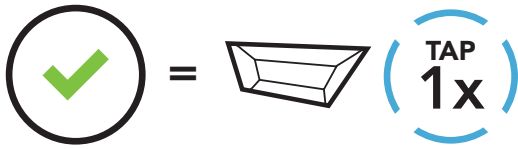

### Headset Configuration Menu

Voice Configuration Menu	Tap the TAP Button
Mobile Phone Pairing	None
Second Mobile Phone Pairing	None
Phone Selective Pairing	None
Media Selective Pairing	None
GPS Pairing	None
Delete All Pairings	Execute
Remote Control Pairing	Execute
Universal Intercom Pairing	Execute
Factory Reset	Execute
Exit Configuration	Execute



### 10.1.1 Delete All Pairings

You can delete all Bluetooth pairing information of the headset.

### 10.1.2 Remote Control Pairing

You can remotely control the headset using **Sena Remote Control devices** (sold separately).

1. Turn on the headset and the Remote Control device.
2. Execute **Remote Control Pairing**.
3. Enter pairing mode in the Remote Control device. The headset will automatically connect with the Remote Control device in pairing mode.

## 10.2 Software Configuration Setting

You can change the settings of the headset through the **SMART HJC BT App** or the **SMART HJC Device Manager**.



### 10.2.1 Headset Language

You can select the device language. The selected language is maintained even when the headset is rebooted.

### 10.2.2 Audio Equalizer (Default: Off)

Increase or decrease the decibel level of different frequency ranges of audio.

- **Balance** will adjust all of the frequency ranges to be the same volume level (0 dB).
- **Bass Boost** will increase the bass range of audio (20 Hz - 250 Hz).
- **Mid Boost** will increase the mid range of audio (250 Hz - 4 kHz).
- **Treble Boost** will increase the high range of audio (4 kHz - 20 kHz).

### 10.2.3 VOX Phone (Default: Enable)

If this feature is enabled, you can answer incoming calls by voice. When you hear a ringtone for an incoming call, you can answer the phone by saying a word such as **"Hello"** loudly or by blowing air into the microphone. **VOX Phone** is temporarily disabled if you are connected to intercom. If this feature is disabled, you have to tap the **TAP Button** to answer an incoming call.

### 10.2.4 VOX Intercom (Default: Disable)

If this feature is enabled, you can initiate an intercom conversation with the last connected intercom friend by voice. When you want to start intercom, say a word such as **"Hello"** loudly or blow air into the microphone. If you start an intercom conversation by voice, the intercom terminates automatically when you and your intercom friend remain silent for 20 seconds. However, if you manually start an intercom conversation by tapping the **TAP Button**, you have to terminate the intercom conversation manually. However, if you start the intercom by voice and end it manually by tapping the **TAP Button**, you will not be able to start intercom by voice temporarily. In this case, you have to tap the **TAP Button** to restart the intercom. This is to prevent repeated unintentional intercom connections by strong wind noise. After rebooting the headset, you can start intercom by voice again.

### 10.2.5 HD Intercom (Default: Enable)

**HD Intercom** enhances the two-way intercom audio from normal quality to HD quality. If this feature is disabled, the two-way intercom audio will change to normal quality.

**Note:**

- The intercom distance of **HD Intercom** is relatively shorter than that of normal intercom.
- **HD Intercom** will become disabled temporarily when **Audio Multitasking** is enabled.

### 10.2.6 HD Voice (Default: Enable)

**HD Voice** allows you to communicate in high-definition during phone calls. This feature increases the quality so that the audio will be crisp and clear during phone call conversations.

If this feature is enabled, incoming phone calls will interrupt intercom conversations and audio from the SR10 will not be heard during intercom conversations.

**Note:**

- Refer to the manufacturer of your Bluetooth device that will be connected to the headset to see if it supports **HD Voice**.
- **HD Voice** is active only when **Audio Multitasking** is disabled.

## 10.2.7 Audio Multitasking™ (Default: Disable)

**Audio Multitasking** allows you to hear the audio from two features simultaneously. When **Audio Multitasking** is enabled, phone calls, GPS instructions, and intercom conversations can be overlaid with audio from the music or GPS app instructions from a smartphone in the background with reduced volume. Increasing or decreasing the volume of the audio in the foreground will also increase or decrease the volume of the overlaid audio in the background. The volume of the foreground audio can be adjusted using the headset. How much background audio that is heard can be adjusted using the **SMART HJC Device Manager** or the **SMART HJC BT App**. **HD Intercom**, **HD Voice**, and **Audio Source Priority** become disabled temporarily when **Audio Multitasking** is enabled.

**Foreground and Background Combination Table**

Model	Foreground*			Background**
	Phone	GPS	Intercom	Music or Smart Navi
SMART HJC 21B	<input type="radio"/> <sup>A</sup>	<input type="radio"/> <sup>A</sup>		
		<input type="radio"/>	<input type="radio"/>	
			<input type="radio"/> <sup>B</sup>	<input type="radio"/> <sup>B</sup>
		<input type="radio"/>		<input type="radio"/>

\* Two audio sources in the foreground can be heard simultaneously with the same volume level.

\*\* Only one background source can be heard at a time while listening to an audio source in the foreground.

A. GPS instructions can be heard during phone calls and the volume level of both audio sources can be adjusted using the headset.

B. GPS app directions will be heard in the background during intercom conversations.

### Note:

- **Audio Multitasking** will be activated during two-way intercom conversations with a headset that also supports this feature.
- When **Audio Multitasking** is disabled, the background audio source will return to its independent volume level.
- For **Audio Multitasking** to work properly, you need to power the headset off and on. Please restart the headset.
- Some GPS devices may not support this feature.

### 10.2.8 Background Volume (Default: Level 5)

The **Background Volume** can be adjustable only when the **Audio Multitasking** turns on. Level 9 is the highest volume and 0 is the lowest.

### 10.2.9 Audio Source Priority (Default: Intercom)

**Audio Source Priority** allows you to select the priority between the intercom and music (which includes GPS app instructions and message notifications) from a smartphone. If the intercom is selected as the audio source priority, your music will be interrupted during an intercom conversation. If music is selected as the audio source priority, intercom conversations will be interrupted while your music is heard.

**Note: Audio Source Priority** is active only when **Audio Multitasking** is disabled.

### 10.2.10 Voice Prompt (Default: Enable)

You can disable **Voice Prompts** by software configuration settings, but the following voice prompts are always on.

- Headset configuration settings menu, battery level indicator, speed dial

### 10.2.11 Advanced Noise Control™ (Always On)

The background noise is reduced during an intercom conversation.

# 11. TROUBLESHOOTING

Please visit [www.smarthjc.com](http://www.smarthjc.com) for more troubleshooting information.

- Customer Support: [www.smarthjc.com](http://www.smarthjc.com)

## 11.1 Fault Reset

When the headset is not working properly, you can easily reset the unit:

1. Locate the **Pinhole Fault Reset Button** next to the DC Power Charging & Firmware Upgrade Port.
2. Gently insert a paper clip into the hole and press the **Pinhole Fault Reset Button** with light pressure.

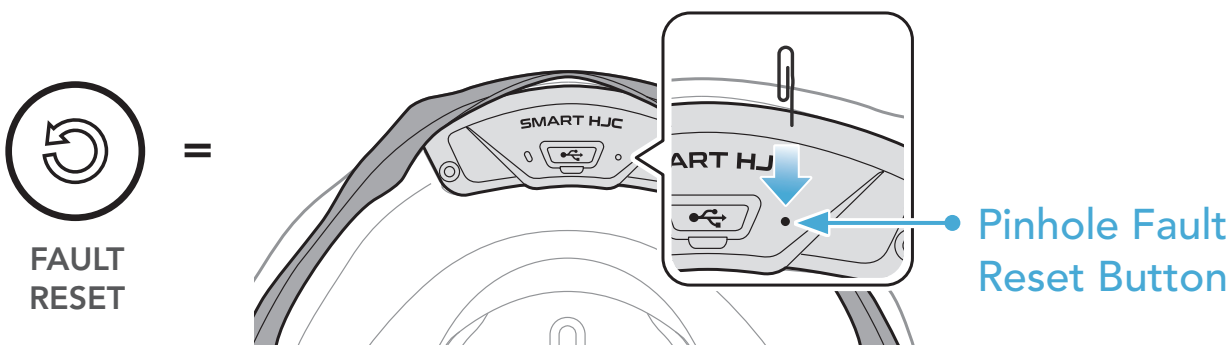

3. The headset will shut down.





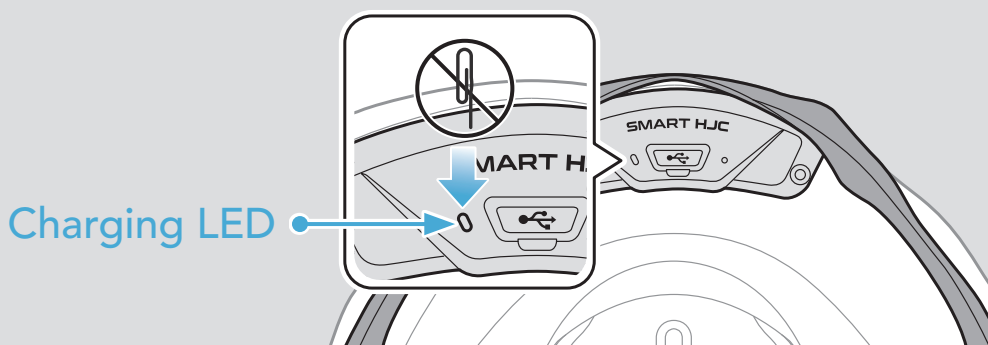







### Note:

- **Fault Reset** will not restore the headset to factory default settings.
- The charging LED is not the **Pinhole Fault Reset Button**. Do not press it.



## 11.2 Factory Reset

To erase all of your settings and start fresh, the headset can be restored to factory default settings using the **Factory Reset** feature.

1.  =   →  "Configuration menu"
2.  =   →  "Factory reset"
3.  =   →  "Headset reset, good-bye"