



ARK²

AERODYNAMIC
COMMUNICATION
SYSTEM
FOR AGV HELMETS



USER MANUAL

 Bluetooth® **SENA**



AGV is a brand owned by Dainese S.p.A., company with QMS certified in accordance to ISO 9001 standard.

Sena™, Group Intercom™, Universal Intercom™, Audio Overlay™, Advanced Noise Control™ are trademarks owned by Sena Technologies, Inc.

The Bluetooth® logo and wordmark are owned by Bluetooth SIG, Inc. and any use of such marks by Sena Technologies, Inc. is under license.

GoPro® is a brand owned by Woodman Labs, Inc.

Other trademarks and trade names are those of their respective owners.

The products shown in the images are considered to be indicative and may differ from the product purchased. Dainese reserves the right to make changes to the product and to the respective documentation without notice. To make sure that you have the documentation in the most recent update available, please visit <http://oem.sena.com/agv>.

INDEX

SAFETY INFORMATION	06
1 INTRODUCTION	08
ARK features	08
2 COMPONENTS	09
3 ASSEMBLY	10
3.1 Assembling the support unit on the helmet	10
3.2 Assembling ARK on the support unit and installation of peripherals	12
4 INTRODUCTORY NOTIONS	14
4.1 Operations of the buttons	14
4.2 Switching on and off	14
4.3 Charging	15
4.4 Checking the battery level	15
4.5 Volume control	16
4.6 Deactivating the microphone	16
4.7 Support software	16
5 PAIRING WITH BLUETOOTH® DEVICES	17
5.1 Pairing with smartphone - phone, Bluetooth® stereo device	17
5.2 Pairing with a second smartphone	18
5.3 Advanced selective pairing A2DP stereo or HFP phone	19
5.4 Pairing with GPS navigator	20
5.5 Intercom pairing with other ARK devices	21
6 PHONE AND GPS	22
6.1 Making and answering calls	22
6.2 Speed dial	23
7 STEREO MUSIC	24
7.1 Bluetooth® stereo music	24
7.2 Music sharing	25
8 INTERCOM	26
8.1 Two-way intercom	26
8.2 Three-way intercom	27
8.3 Four-way intercom	29
9 PHONE AND INTERCOM SIMULTANEOUSLY	30
9.1 Phone call during intercom conversation	30
9.2 Intercom call during a telephone conversation	31
9.3 Telephone conference with three-way intercom participant	31
10 GROUP INTERCOM™	31
11 UNIVERSAL INTERCOM™	32
11.1 Universal Intercom™ pairing	33
11.2 Two-way Universal Intercom™	34
11.3 Three-way Universal Intercom™	34
11.4 Four-way Universal Intercom™	36

12 FM RADIO	38
12.1 Switching on and off radio FM.....	38
12.2 Preset stations.....	38
12.3 Station search	39
12.4 Saving and deleting preset stations.....	39
12.5 Scanning and saving.....	40
12.6 Provisional presetting.....	41
12.7 FM sharing.....	41
12.8 Area selection	41

13 PRIORITY FUNCTIONS	42
------------------------------------	-----------

14 ARK CONFIGURATION SETTINGS	43
14.1 Phone pairing	44
14.2 Second mobile phone pairing	44
14.3 GPS pairing.....	44
14.4 Phone selective pairing.....	44
14.5 Media selective pairing	45
14.6 Delete all pairings.....	45
14.7 Remote Control pairing.....	45
14.8 Universal Intercom™ pairing	45
14.9 Factory Reset	46
14.10 Configuration exit	46

15 SOFTWARE CONFIGURATION SETTINGS.....	46
15.1 Assignment of the speed dial.....	46
15.2 Audio source priority setting	47
15.3 Enable/disable the audio boost	47
15.4 Enable/disable the smart volume control.....	47
15.5 Enable/disable the VOX phone.....	48
15.6 Enable/disable the VOX intercom	48
15.7 Enable/disable HD Voice	49
15.8 Enable/disable HD intercom.....	49
15.9 Setting of VOX sensitivity.....	50
15.10 Enable/disable voice prompt	50
15.11 Enable/disable RDS AF settings.....	50
15.12 Enable/disable FM station guide.....	50
15.13 Enable/disable Sidetone	51
15.14 Enable/disable Advanced Noise Control™	51
15.15 Enable/disable Audio Overlay™	51

16 FIRMWARE UPDATE	53
---------------------------------	-----------

17 TROUBLESHOOTING	53
17.1 Reset after error.....	53
17.2 Factory Reset	53

18 QUICK REFERENCE	54
---------------------------------	-----------

CERTIFICATION AND SAFETY APPROVALS.....	55
--	-----------

AFTER SALES SERVICES	58
-----------------------------------	-----------

SAFETY INFORMATION

Please ensure that the product is properly used by observing the warnings and cautions below to prevent any risk and/or damage to property.

PRODUCT STORAGE AND MANAGEMENT

- Keep the product free of dust. It may damage mechanical and electronic parts of the product.
- Do not store the product in high temperatures as this may reduce the life span of electronic devices, damage the battery, and/or melt plastic parts of the product.
- Do not store the product in cold temperatures. Abrupt changes in temperatures may cause condensation and damage electronic circuits.
- Do not clean the product with cleaning solvents, toxic chemicals, or strong detergents as this may damage the product.
- Do not paint the product. Paint may obstruct moving parts or interfere with the normal operation of the product.
- Do not drop or otherwise shock the product. It may damage the product or its internal electronic circuits.

- Do not disassemble, repair or modify the product as this may damage the product and invalidate the product warranty.
- Do not store the product in humid environments, especially for long time storage.

PRODUCT USE

- In some regions, it is prohibited by law to ride motorcycles while wearing headsets or earbuds. Therefore, be certain to comply with all relevant laws in the region before using the product.
- The headset is for motorcycle helmets only. To install the headset, you must follow the installation instructions shown in the User's Guide.
- Use of the product at a high volume for a long period of time may damage your eardrums or hearing ability. Keep the volume at a modest level to prevent damage.
- Do not cause impact to the product or touch it with sharp tools as this may damage the product.
- Do not use the product in high-temperatures or apply heat to the product as this may cause damage, explosion, or fire.
- Keep product away from pets or small children. It may damage the product.

- In any place where wireless communication is prohibited, such as hospitals or airplanes, turn off the power and refrain from using the product. In a place where wireless communication is prohibited, electromagnetic waves may cause hazards or accidents.
- Do not use the product near hazardous explosives. When it is near any explosion hazards, turn off the power and heed any regulations, instructions, and signs in the area.
- When using the product, be certain to conform to laws regarding the use of communications devices while riding.
- Do not put the product where it may hamper the rider's vision or manipulate it while riding. This may cause traffic accidents.
- Before riding, fasten the product to the helmet, and double-check that it is fastened. Separation of the product while riding may cause damage to the product or accidents.
- If the product is damaged, stop using it immediately. It may cause damage, explosion, or fire.

BATTERY

This product has an irreplaceable rechargeable battery inside. Therefore, when using the product, make sure to adhere to the following:

- Never separate the battery from the product as this may damage the product.
- The battery performance may be reduced over time with usage.
- Any 3rd party USB charger can be used with Sena™ products if the charger is approved by either the FCC, CE, IC or other locally approved agencies that Sena™ accepts.
- Store the battery at temperatures of 15°C ~ 25°C (59°F ~ 77°F). Higher or lower temperatures may reduce the capacity and life of the battery, or may cause temporary non-operation. Do not use the product in sub-zero temperature, because it may cause serious reduction of the battery performance.
- If you apply heat to the battery or throw it into fire, it may explode.
- Do not use the product with a damaged battery. It may explode and/or cause accidents.
- Never use a damaged charger. It may explode and/or cause accidents.
- Battery life may vary depending on conditions, environmental factors, functions of the product in use, and devices used with it.

1 INTRODUCTION

ARK is a stereo Bluetooth® and intercom headset. Please read this User manual carefully before using the device.

ARK FEATURES

- Bluetooth® V4.1
- Bluetooth® intercom with a maximum range of 1.6 km **(*)**
- Four-way Intercom
- Group Intercom™
- Universal Intercom™
- Integrated FM radio tuner with station search and mute function
- Sharing music
- Audio Overlay™
- Advanced Noise Control™
- Voice Prompt
- Sena™ Motorcycles application
- Quick charge
- AGV remote control support (accessory not included)
- Firmware update
- Natural, crystal clear sound quality
- Firmware update option
- Water resistant
- Operating Temperature: -10°C / +45°C.
While charging the battery, the allowed temperature range is reduced to 0°C / 35°C.

(*) Notice!

Communication distance performances can be achieved in a controlled environment. Helmet materials and ambient conditions can strongly influence them.

2 COMPONENTS

ARK

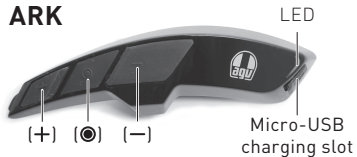

Support unit

accessory not included



Charger cable



Microphone for full face helmet with tear-off strip and cover



Earphones with tear-off strip and cover



Microphone for modular helmet and jet with tear-off strip and cover



Connection unit



3 ASSEMBLY

3.1 ASSEMBLING THE SUPPORT UNIT ON THE HELMET

- A. Guide the wiring of the connection unit **(1)** through the wiring passage in the support unit **(2)**.

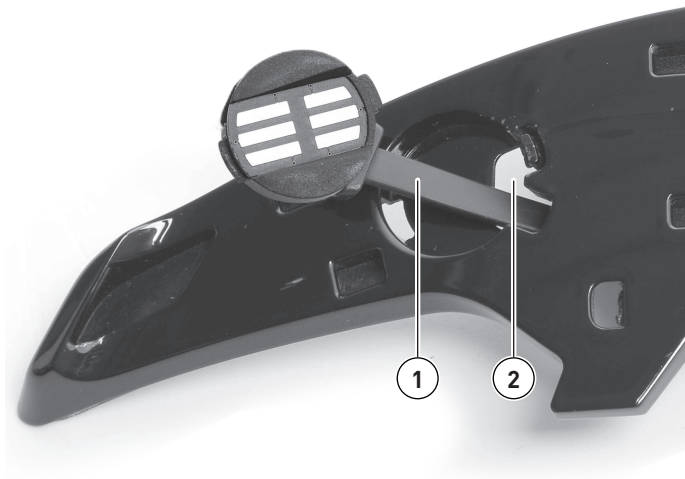

- B. Locate the connection unit **(3)** in the slot in the support unit, making sure that the metal contacts **(4)** are outwardly oriented.

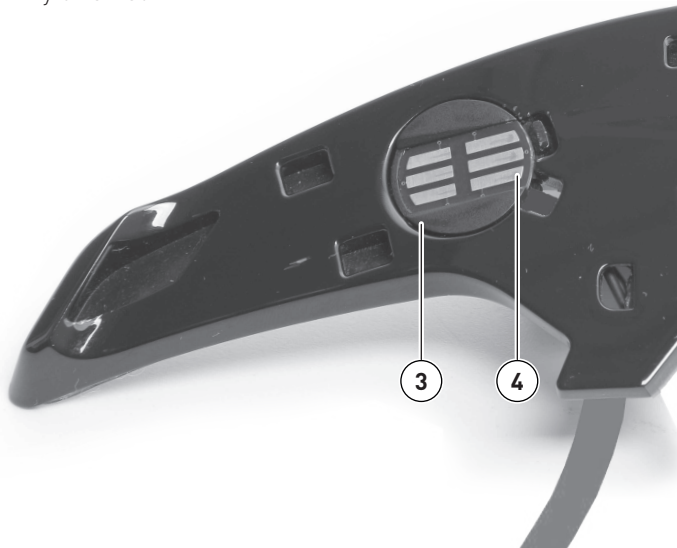

- C. Cut out the adhesive positioning mask **(5)** and apply it to the surface of the shell. The mask is supplied with the instructions (the images in this document are for reference only) inside the packaging of the support unit.

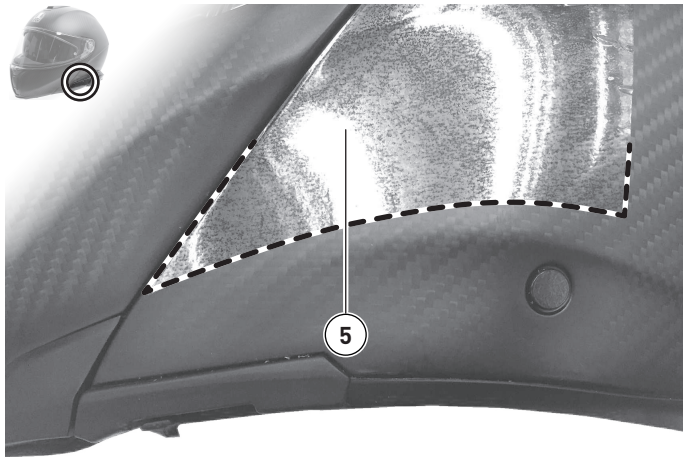

- D. Remove the adhesive from the back of the support unit and stick it to the helmet shell by aligning it with the edge **(6)** of the adhesive positioning mask.
- E. Remove the adhesive positioning mask from the shell.

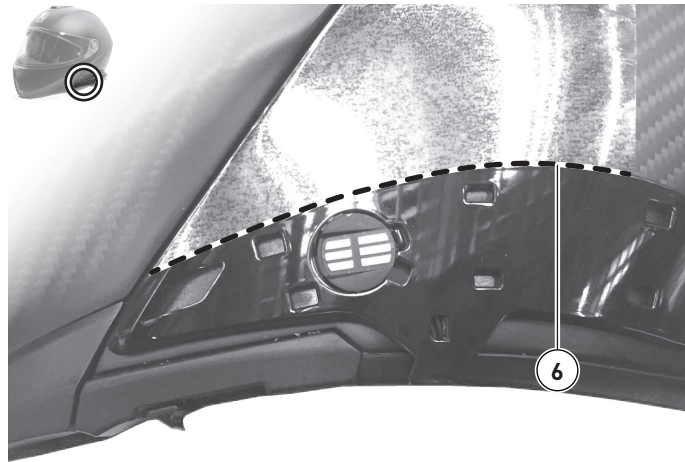

3.2 ASSEMBLING ARK ON THE SUPPORT UNIT AND INSTALLATION OF PERIPHERALS

- A. Attach ARK to the support unit by carrying out the movement in two stages:
1. Place ARK on the support unit by inserting the engagement pins in the six specific locations **(7)**;
 2. Push ARK towards the front of the helmet by tying the front tooth **(8)** to the support unit. A “click” identifies a secure engagement **(*)**.

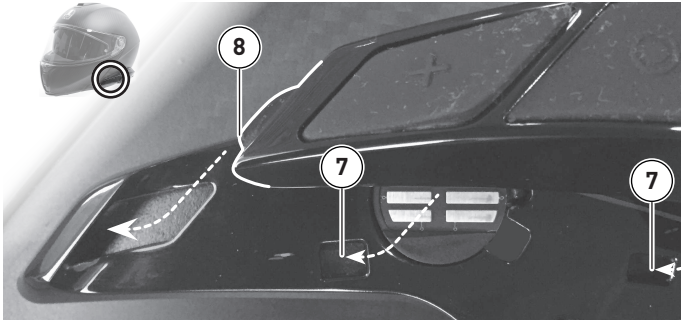

- B. Once the side pads have been removed (refer to the Helmet User Manual), make the wiring connections paying attention to the pairing direction of the male and female terminals **(9)**. Black terminals connect the earphones, and red terminals connect the microphone.

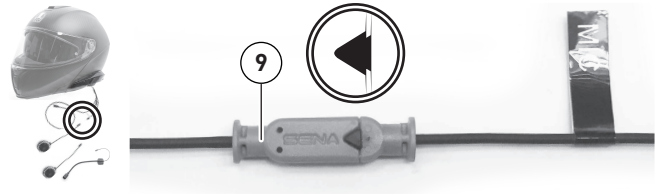

- C. Apply the earphones **(10)** to the earphone housing in the polystyrene shell using the adhesive stripe **(11)**.

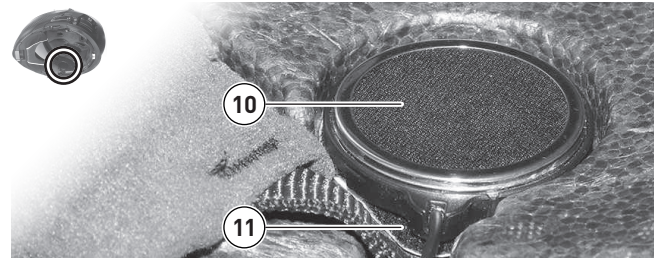

- D. If you have a jet or modular helmet, apply the jet helmet microphone (12) to the polystyrene shell using the supplied adhesive stripe (13). Apply the jet or modular helmet microphone to the inner surface of the chin guard at the mouth.



- E. If you have a full face helmet, apply the full face helmet microphone (14) to the inner surface of the chin guard at the mouth using the supplied adhesive stripe (15). The full helmet microphone must not be used on jet helmets.

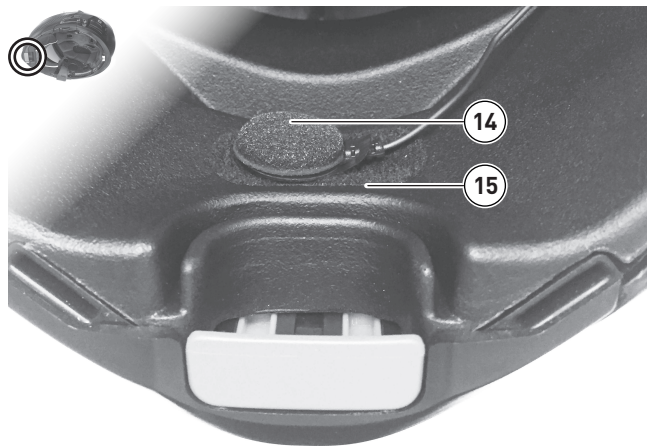

 **[*] Warning!** Make sure that ARK is firmly connected to the support unit: press the back of the ARK against the support unit, ensuring that the coupling tooth has completed the engagement.

4 INTRODUCTORY NOTIONS

4.1 OPERATION OF THE BUTTONS

Central button

Answering and ending a phone call
 Rejecting an incoming call on your smartphone
 Start and end intercom communication
 Playing and pausing the Bluetooth® MP3 player
 Accessing intercom pairing mode
 Accessing the voice configuration setting

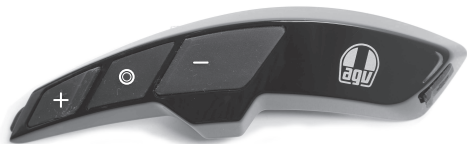

[+] Button

Volume increase
 Next track
 Analysis of FM radio stations
 Speed dial

[-] Button

Volume decrease
 Previous track
 Turning FM radio on/off

4.2 SWITCHING ON AND OFF

To turn on ARK, press the centre button and the (+) button simultaneously for 1" while increasing beeps and the voice prompt "Hello" are being played. To turn off ARK, press the centre button and (+) button for 1" at the same time while decreasing intensity beeps and the "Goodbye" voice prompt are being played.

4.3 CHARGING

To charge ARK, connect the supplied power and data transfer cable to the USB port of a computer or to a USB charger. ARK can be charged with most standard micro-USB cables.

During charging, the LED lights up in red. When charging is complete, the LED lights up blue.

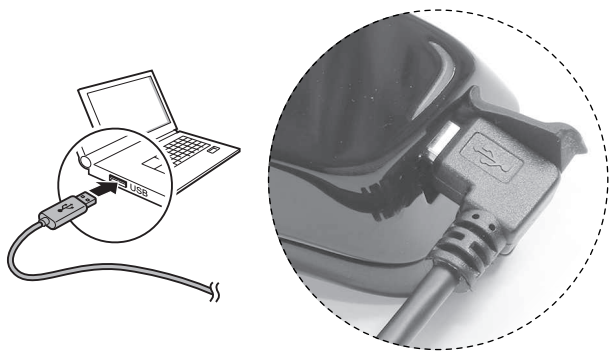

4.4 CHECKING THE BATTERY LEVEL

4.4.1 LED indicator

When the ARK is switched on, the LED flashes rapidly in red, indicating the battery level:



charged between 70% and 100%
 charged between 30% and 70%
 charged between 0% and 30%

4.4.2 Voice prompt indicator

When the ARK is turned on, press and hold the centre button and (+) button together for 5". A voice prompt will then sound to indicate the battery level.



Notice!

If you release the buttons as soon as you turn on ARK and before 5" has elapsed, the voice prompt indicating the battery level is not emitted.

4.5 VOLUME CONTROL

Pressing the button (+) or the button (-) allows you to easily adjust the volume.

The volume is independently set and maintained at different levels for each audio source, even when ARK is restarted.

For example, once you set the volume for your phone (i.e. during a call), the level will not be changed when you adjust the volume of the Bluetooth® MP3 player's music (i.e. while listening to an MP3 track). However, if the volume is adjusted with ARK in standby mode, this will affect the volume levels of all audio sources.

4.6 DEACTIVATING THE MICROPHONE

To turn the microphone off or on again, press and hold the centre button and the (-) button for 1”.

When the microphone is off, beeps are emitted every 10” with decreasing intensity.

When the microphone is reactivated, an audible signal of increasing intensity sounds and the microphone is active.

4.7 SUPPORT SOFTWARE

4.7.1 Sena™ Device Manager

Sena™ Device Manager allows you to update the firmware and configure device settings directly from your PC.

Thanks to this software you can assign presets for speed dial, FM frequencies and other functions. For more information on downloading the Sena™ Device Manager, see webpage <http://oem.sena.com/agv>.

4.7.2 Sena™ Motorcycles app

The Sena™ Motorcycles app allows you to configure the device settings and consult the Quick Reference Guide.

Pair your phone with ARK (see section 5.1, “Pairing with smartphones – phones, Bluetooth® Stereo device”).

Using the Sena™ Motorcycles app, you can configure the ARK settings directly from your smartphone. You can download the Sena™ Motorcycles application from <http://oem.sena.com/agv>.

5 PAIRING WITH BLUETOOTH® DEVICES

To use ARK in pairing with other Bluetooth® devices, you must pair them with each other for the first time.

ARK can be paired with Bluetooth® phones, Bluetooth® stereo devices such as MP3 players, motorcycle-specific Bluetooth® GPS navigators and other ARKs. Pairing is only necessary once for each Bluetooth® device.

ARK remains paired with the devices and reconnects automatically when they are within the maximum range. Whenever ARK reconnects to the paired device, a single high tone beep and the voice prompt “Phone connected” if a phone is used, “Media connected” if a Bluetooth® stereo device are used.

The pairing of Bluetooth® devices can be done from the configuration menu. To access the Configuration voice menu, press and hold the center button for 10” until the voice prompt “Configuration menu” is emitted.



Notice!

Pressing and holding the centre button for 6” you’ll hear the voice prompt “Intercom pairing”. Ignore the signal and continue to press and hold until you hear the “Configuration menu” voice prompt.

To exit the configuration menu without pairing and return to standby mode, press the (+) button until you hear the message “Exit configuration”, then press the center button. Alternatively, wait without performing any operation.

5.1 PAIRING WITH SMARTPHONE - PHONE, BLUETOOTH® STEREO DEVICE

1. To access the configuration voice menu, press and hold the centre button for 10” until you hear the “Configuration menu” voice prompt.
2. Press the (+) button. The voice prompt “Phone pairing” is emitted.
3. Search for Bluetooth® devices on your phone and then select “AGV ARK” from the list of devices detected on your phone.
4. Enter 0000 as a PIN (it may not be required or a confirmation may be requested).

5. The phone confirms that pairing has taken place. The voice prompt "Paired devices" is emitted.
6. If the pairing process does not end within 3', ARK returns to standby mode.

 **Notice!**

If a Bluetooth® connection between ARK and a phone is interrupted, press the centre button for 3" until a single high tone sounds to re-establish the Bluetooth® connection immediately.

If a Bluetooth® connection between ARK and a media player is interrupted, press the centre button for 1" to restore the Bluetooth® connection and start playback.

5.2 PAIRING WITH A SECOND SMARTPHONE

ARK can connect to a second Bluetooth® device, such as a second phone or MP3 player.

1. To access the Setup voice menu, press and hold the centre button for 10" until you hear the "Configuration menu" voice prompt.
2. Press the (+) button repeatedly until the voice prompt "Second mobile phone pairing" is heard.

3. Search for Bluetooth® devices on your phone. Select "AGV ARK" from the list of devices detected on your phone.
4. Enter 0000 as PIN (may not be required or confirmation may be required).
5. The phone confirms that pairing has taken place. The voice prompt "Your headset is paired" is emitted.

 **Notice!**

If two multimedia audio devices (A2DP) are connected to ARK, the audio of one device will interrupt audio testing - nothing from the other device. For example, if you are playing music from the primary phone, it can be interrupted by playing music from the second phone and vice versa.

5.3 ADVANCED SELECTIVE PAIRING A2DP STEREO OR HFP PHONE

When using a smartphone, ARK normally allows both stereo music playback and remote management. However, sometimes you may need to use ARK selectively for stereo music only or for phone calls only. These instructions are intended for experienced users who only wish to pair ARK with smartphones with a selective profile: A2DP for stereo music or HFP for phone calls.

If you previously paired a phone with ARK, you must clear the previous pairing list on both devices: phone and ARK. To reset the pairing list to ARK, perform a factory reset or follow the procedure to reset the pairing list described in section 14.9, Factory Reset, or 14.6, Delete all pairings. To clear the pairing list on your phone, refer to your phone's manual (or, for most smartphones, delete ARK from the Bluetooth® device list in the settings menu).

5.3.1 A2DP stereo music only

To access the Setup voice menu, press and hold the centre button for 10" until the "Configuration menu" voice prompt is emitted.

Press the (+) button until the "Media selective pairing" voice prompt is emitted.

Search for Bluetooth® devices on your smartphone. Select AGV from the list of devices detected on your phone.

Enter 0000 as PIN (may not be required or confirmation may be required).

The phone confirms that pairing has taken place and that ARK is ready to use. The voice prompt "Your headset is paired" is emitted.

5.3.2 HFP call only

To access the Setup voice menu, press and hold the centre button for 10" until the "Configuration menu" voice prompt is emitted.

Press the (+) button until the "Phone selective pairing" voice prompt is heard.

Search for Bluetooth® devices on your smartphone. Select "AGV ARK" from the list of devices detected on your phone.

Enter 0000 as PIN (may not be required or confirmation may be required).

The phone confirms that pairing has taken place and that ARK is ready to use. The voice prompt "Your headset is paired" is emitted.

5.4 PAIRING WITH GPS NAVIGATOR

5.4.1 GPS pairing

1. To access the Configuration voice menu, press and hold the center button for 10" until the "Configuration menu" voice prompt is emitted.
2. Pressing the (+) button repeatedly until the "GPS pairing" voice prompt is emitted.
3. Search for Bluetooth® devices on the GPS navigation screen. Select "AGV ARK" from the list of detected devices.
4. Enter 0000 as PIN (confirmation may or may not be required).
5. The GPS confirms successful pairing and that ARK is ready for use. The voice prompt "Your headset is paired" is emitted.
6. If the pairing process is not completed within 3', ARK returns to standby mode.



Notice!

You must use GPS specifically designed for motorcycles, that transmit voice instructions via Bluetooth®. Most car GPS systems do not have this feature.

When Audio Overlay™ is enabled, if you pair the GPS device via GPS pairing, its instructions do not interrupt intercom conversations but overlay them.

5.4.2 Pairing as mobile phone

If GPS is also your preferred source of Bluetooth® stereo music, you can pair GPS to ARK by following the simple procedures described in 5.1, "Pairing with smartphone - phones, Bluetooth® stereo device". In this case, ARK interprets the GPS as if it was a phone, so you cannot pair the phone to ARK. However, some GPS systems support the AC Bluetooth® bridging, so the phone can be paired to them, irrespective of ARK.

5.5 INTERCOM PAIRING WITH OTHER ARK DEVICES

ARK can be paired with up to three other ARK devices (or equivalent compatible systems) for a Bluetooth® intercom conversation.

1. Switch on two ARK devices (A and B) to be paired.
2. On both ARK device, press and hold the centre button for 5", until you hear a single mid-tone beep and the voice prompt "Intercom pairing".
3. Simply press the center button of one of the two ARK devices and wait for the intercom connection to be established automatically. The two ARK devices A and B are paired with each other for intercom conversation. If the pairing procedure does not end within 1', ARK returns to standby mode.

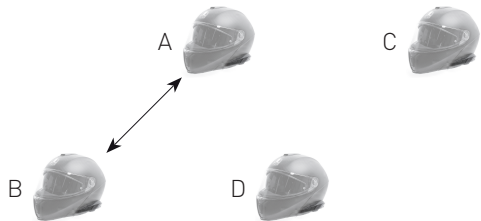

4. Following the same procedure described previously, other pairings can be made between ARK A and C and between ARK A and D.
5. The intercom pairing sequence is of the LCFS (Last Come, First Served) type. If ARK is paired to multiple intercom conversational devices, then you have the following situation:
 - The last paired ARK is set as the first intercom friend.
 - The previously paired ARK becomes the second intercom friend.
 - The first of the three paired ARKs becomes the third friend intercom.

Notice!

For example, after the pairing procedures described above, D is the first intercom friend of A; C is the second intercom friend of A; B is the third intercom friend of A.

6 PHONE AND GPS

6.1 MAKING AND ANSWERING CALLS

1. In the event of an incoming call, press the center button to answer the call.
2. In addition, you can answer the incoming call by saying aloud any word of your choice, if the VOX phone is enabled.



Even if enabled, the active voice answering feature will not work if no intercom communication is in progress.

3. To end a call, press the centre button for 2" until a single high-pitched signal of average tone is emitted, or wait for the keyed person to end the conversation.

4. To reject a call, press the centre button for 2" until you an acoustic signal is emitted while the phone rings.
5. You can make a call in different ways:
 - A. Enter the number on the phone keypad and make the call. The call is automatically transferred to ARK.
 - B. In standby mode, press the center button for 3" to activate the voice dialling of the phone. For this purpose, the mobile phone must be equipped with a voice dialling function. For further instructions, refer to your phone's manual.

 **Notice!**

If two mobile phones are connected to ARK and there is a call from the second mobile phone during the call from the first mobile phone, it is still possible to receive the call from the second mobile phone. In this case, the call from the first phone is put on hold. If you end the second call, it automatically switches to the first phone call.

If a phone and GPS are connected to ARK, you cannot hear the GPS voice instructions during the call.

The voice dialling function is closely dependent on the phone and may not work as expected in conjunction with ARK.

6.2 SPEED DIAL

You can make a speed dial call using the speed dial voice menu.

1. To access the speed dial voice menu, press and hold the (+) button for 3"; a single medium tone beep and the voice prompt "Speed dial" will sound.
2. Press the (+) or (-) button to navigate through the menus. Voice prompts are emitted:
 - Last number redial (to repeat the number of the last call)
 - Speed dial 1 (to make a call to speed dial number 1)
 - Speed dial 2 (to make a call to speed dial number 2)
 - Speed dial 3 (to make a call to speed dial number 3)
 - Cancel

3. Press the center button to select the desired option.
4. If you want to leave the speed dial immediately, press the (+) or (-) button until you hear the "Cancel" voice prompt, then press the centre button. If no button is pressed within 15", ARK leaves the voice menu of the call and returns to standby mode.

 **Notice!**

Before using the speed dial, you must assign the speed dial numbers (see section 15.1, "Assignment of the speed dial").

7 STEREO MUSIC

7.1 BLUETOOTH® STEREO MUSIC

The Bluetooth® audio device must be paired with ARK following the procedures "Pairing with Smartphone - Phone, Bluetooth® Stereo Device" described in section 5.1. ARK supports the Bluetooth® audio/video remote control profile (AVRCP), so if your Bluetooth® audio device also supports the AVRCP profile, you can use ARK to remotely control music playback using the play, pause, next track and previous track controls.

1. To play or pause music, press the centre button for 1" until a double beep sounds.
2. To adjust the volume, press the (+) or (-) button.
3. To skip to the next or previous track, press and hold the (+) or (-) button for 1" until a beep sounds.

The first time music playback is started; in some cases, it is not possible for it to be played directly from the Bluetooth® device.

7.2 MUSIC SHARING

You can start sharing Bluetooth® stereo music with an intercom friend during a two-way intercom conversation (see section 8.1, Two-way intercom). Once you have finished sharing music, you can return to the intercom conversation. To start or stop music sharing after activating the two-way intercom conversation (see 8.1), press and hold the centre button for 1". To skip to the next or previous track, press and hold the (+) or (-) button for 1".



Notice!

Once Bluetooth® stereo music sharing has started, both the user and the intercom friend can control the playback of music remotely, for example, to pause or resume playback, or to move to the next or previous track.

To close the two-way intercom session, the user and the intercom friend must first stop playing the music (press the center button for 1" until you hear a double beep). The music sharing will be paused when using a phone or listening to GPS instructions.

Music sharing will stop if ARK starts a multi-voice intercom conference.

When Audio Overlay™ is enabled, if you make an intercom call while listening to music, sharing music will not work.

8 INTERCOM

Make sure that the intercom devices are paired as described in section 5.5, Intercom pairing with other ARK devices.

8.1 TWO-WAY INTERCOM

8.1.1 Starting a two-way intercom

You can start an intercom conversation with any intercom friend by pressing the center button.

- Press the center button for intercom with your first intercom friend once.
- Press the center button twice for intercom with your second intercom friend.
- Press the center button for intercom with your third intercom friend three times.

The first, second and third intercom friends are defined according to the order in which the pairing was made, as described in paragraph 5.5, Intercom pairing with other ARKs.

Notice!

The intercom pairing order and the resulting number of friends remains the same even if some friends are not connected. For example, if the first intercom friend is not connected, the second and third intercom friends are always connected respectively by two or three presses of the center button.

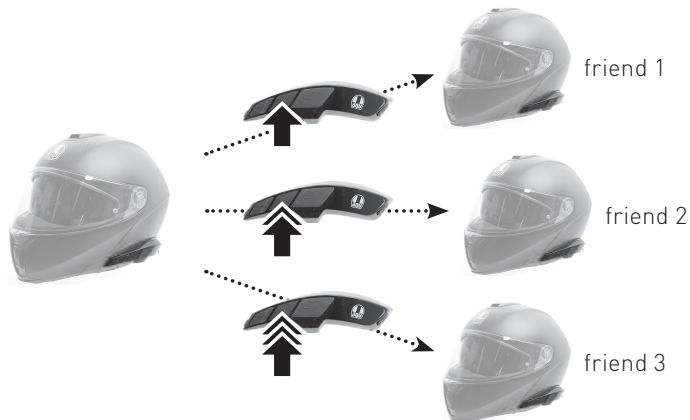

8.1.2 End two-way intercom

You can interrupt an intercom conversation using the center button.

- Press the centre button once to end the intercom with your first intercom friend.
- Press the centre button twice to end the intercom with your second intercom friend.
- Press the centre button three times to end the intercom with your third intercom friend.

8.2 THREE-WAY INTERCOM

8.2.1 Start three-way intercom

User (A) can create a three-voice intercom conference with other ARK friends (B and C) by establishing two intercom connections at the same time.

1. For the three-voice intercom conference, the user (A) must be paired with two other intercom friends (B and C).

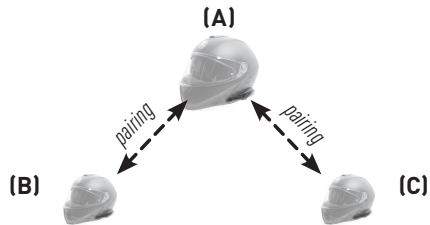

2. Start an intercom conversation with one of the two friends in the intercom group. The user (A), for example, can start an intercom conversation with the intercom friend (B). In alternative, the intercom friend (B) can start a conversation in intercom with the user (A).

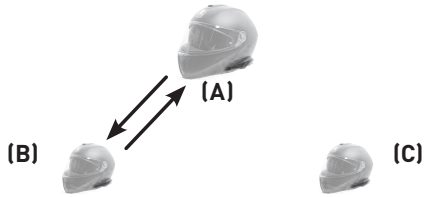

3. The user (A) can call the second intercom friend (C) by pressing the center button a number of times to the friend to be called (see 8.1), or the second intercom friend (C) can join the intercom conversation by making an intercom call to the user (A).

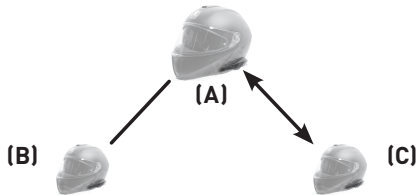

4. At this point, the user (A) and the other two intercom friends (B and C) are holding a three-way conference intercom.

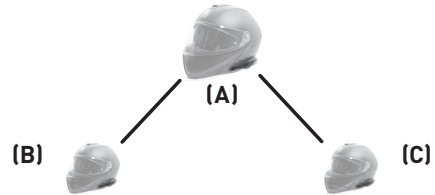

Notice!

While a three-way conference intercom is in progress, the connection of the mobile phones of the three participants is temporarily interrupted. However, as soon as the intercom conference is over or one of the participants leaves the intercom conversation, all mobile phones automatically reconnect to the ARK calls. If you have an incoming call on your phone during an intercom conference, end the intercom conference to automatically reconnect and receive the call.

The actual addition of the second intercom friend to the three-way conference intercom may take a few seconds to wait.

8.2.2 End three-way intercom

You can completely end the intercom conference or simply interrupt the intercom connection with one of your active intercom friends.

1. To fully end the three-way conference intercom, press the centre button for 3" until you hear a beep. In this way, both intercom connections to (B) and (C) are broken.
2. Press the centre button once or twice to intercom with one of your friends, respectively. For example, by pressing the centre button once, you can only end the connection with your first intercom friend (B). However, the intercom connection with the second intercom friend (C) is not interrupted.

Operation of the center button	Result
Pressure for 3"	Interruption of connection of (B) and (C)
Single pressure	Interruption of (B) connection
Double pressure	Interruption of (C) connection

8.3 FOUR-WAY INTERCOM

8.3.1 Start four-way intercom

You can create a four-voice intercom conference with three other ARK users by adding an extra intercom participant to the three-voice intercom conversation. During a three-voice intercom conversation as described in section 8.2, "Three-way intercom", a new participant (D), a friend of the user (C), can join the intercom conference by making an intercom call to the user (C). Please note that in this case, the new participant (D) is an intercom friend of (C), not of the user (A).



Notice!

The actual addition of the third intercom friend to the four-voice conference may take a few seconds to wait.

8.3.2 End four-way intercom

As with three-way intercom, you can completely end a four-voice intercom conference or only end a single intercom connection.

1. To end the four-voice intercom conference, press the center button for 3" until an acoustic signal is emitted. This terminates all intercom connections between user (A) and intercom friends (B) and (C).

2. Press the centre button once or twice to intercom with one of your friends, respectively. However, if you disconnect the second friend (C) by pressing the center button twice, it will also be disconnected from the third participant (D). This is because the third participant (D) is connected to the user via the second friend (C).

Operation of the center button	Result
Pressure for 3"	Interruption of connection of (B), (C) and (D)
Single pressure	Interruption of (B) connection
Double pressure	Interruption of (C) and (D) connection



Notice!

During multi-way intercom, multiple ARKs are connected. Due to various interfering signals, the intercom distance of the multi-way intercom is relatively shorter than the two-way intercom.

9 PHONE AND INTERCOM SIMULTANEOUSLY

9.1 PHONE CALL DURING INTERCOM CONVERSATION

If during an intercom conversation there is an incoming call on the phone, a ringing tone is heard. You can choose to answer the phone call and interrupt the intercom conversation or to reject the phone call and keep the intercom conversation. Specifically:

- To answer the phone call and end the intercom conversation, press the center button. The VOX Phone feature does not work if you are connected to intercom. When you end the conversation, the intercom will be automatically resumed.
- To reject the telephone call and maintain the intercom connection, press the centre button for 2" until an acoustic signal is heard.

9.2 INTERCOM CALL DURING A TELEPHONE CONVERSATION

In the case of an incoming intercom call during a telephone call, 4 high tone beeps are emitted to indicate the arrival of an intercom call, together with the “Intercom requested” voice prompt. In this case, the intercom call does not prevail over the telephone call because the priority of the intercom is lower than that of the telephone call. You must end the phone call to make or receive an intercom call.

9.3 TELEPHONE CONFERENCE WITH THREE-WAY INTERCOM PARTICIPANT

You can make a three-voice conference call by adding an intercom friend to the current conversation. During a phone conversation, press the center button to invite one of your intercom friends to the phone line. To disconnect the intercom first and then return to the private telephone call, end the intercom by pressing the center button. To end the phone call and keep the Intercom Chat, press the center button for 2” or wait for the person on the phone line to end the call.

Start	Press the center button during a phone call
First, terminate intercom	Press the center button
First, end the phone call	Press the center button for 2” or wait for the person on the telephone line to end the call

10 GROUP INTERCOM™

The Group Intercom™ feature allows you to quickly create a multi-voice intercom conference with three more recently paired ARKs.

1. Pair intercom with up to three ARKs with whom you want to have a Group Intercom™ conversation.
2. Press the (+) and (-) buttons simultaneously to start Group Intercom™. The LED flashes in green and the voice prompt “Group intercom connected” is emitted.
3. To end Group Intercom™, press the center button for 3” during Group Intercom™. The voice prompt “Group intercom terminated” is emitted.

11 UNIVERSAL INTERCOM™

You can create an intercom conversation with devices that are not ARK-compatible (i.e., not Sena™) using the Universal Intercom™ feature. Non-compatible Bluetooth® devices can be connected to ARK if they support Bluetooth® Hands-Free Profile (HFP). The operating distance may differ depending on the performance of the connected Bluetooth® device (usually less than the normal intercom distance).

Universal Intercom™ affects the use of the second phone or GPS: You cannot use a second phone or GPS while using Universal Intercom™, as in the two reported cases.

1. If a non-compatible Bluetooth® device does not support a dual connection to the phone, it is not able to make a phone call while Universal Intercom™ is in use.
2. If a non-compatible Bluetooth® device (already paired as Universal Intercom™ with ARK) is switched on, the connection of a second phone or GPS to ARK is automatically switched off, so these devices cannot be used.

Notice!

Once the second phone or GPS has been disconnected from ARK due to the connection of a non-compatible Bluetooth® device in Universal Intercom™ mode, reconnection of these devices does not occur automatically, even when the non-compatible Bluetooth® device is turned off. You must manually reactivate their connection via their user interface.

Notice!

Some non-compatible Bluetooth® devices may not support three-way and four-way Universal Intercom.

11.1 UNIVERSAL INTERCOM™ PAIRING

ARK can be paired with other non-compatible Bluetooth® devices for an intercom conversation. You can pair ARK with only one non-compatible Bluetooth® device. Therefore, if you pair with a second Bluetooth® device that is not compatible, the previous pairing is deleted.

1. Turn on the ARK and the incompatible Bluetooth® device you wish to pair with.
2. To access the Configuration voice menu, press and hold the centre button for 10" until the "Configuration menu" voice prompt is issued.
3. Press the (+) button until the "Universal Intercom Pairing" voice memo is emitted. Press the centre button to access Universal Intercom™ pairing mode.
4. Perform the operation required for pairing on the non-compatible Bluetooth® device (refer to the user manual of the device to be paired). ARK will automatically pair with the non-compatible Bluetooth® device when both are in pairing mode.



Notice!

Also, the non-compatible device paired with the Universal Intercom mode is included in the sequence "Last come, first served", together with the intercom pairing of ARK systems, as described in paragraph 5.5.

- If pairing in Universal Intercom™ mode is last performed, then the non-compatible device so paired is set as the first intercom friend.
- If an intercom pairing with ARK is made after pairing in Universal Intercom™ mode, the non-compatible device is set as the second intercom friend.
- If two intercom pairings with ARK are made after pairing in Universal Intercom™ mode, then the non-compatible device is set as the third intercom friend.

11.2 TWO-WAY UNIVERSAL INTERCOM™

You can initiate a Universal Intercom™ connection with non-compatible Bluetooth® devices using the same intercom connection method for connecting with other ARK. Depending on the sequence in which Universal Intercom™ was carried out, you can press the centre button once to start an intercom conversation with the first intercom friend, press twice for the second intercom friend and press three times for the third intercom friend.

To start the Universal Intercom™ connection from the non-compatible Bluetooth® device, enable voice dialling of a call or using the last number redial function. The user of the non-compatible Bluetooth® device can also cut-off the existing connection by using the operation to end a call (for voice dialling, redialling and ending a call, refer to the User manual for the relevant non-compatible Bluetooth® devices).

11.3 THREE-WAY UNIVERSAL INTERCOM™

You can make a three-item Universal Intercom™ connection with two ARKs and a non-compatible Bluetooth® device. If a three-way intercom connection is made with Universal Intercom™, all connected devices cannot use the telephone call function because the connection between ARK and the telephone is temporarily interrupted. If the intercom call is interrupted, the main phone connection is automatically restored.

1. For three-way intercom conferencing, (A) must be paired with a non-compatible Bluetooth® device (B) and another ARK (C).

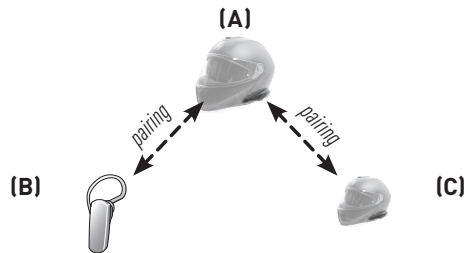

2. Start an intercom conversation with an incompatible Bluetooth® device (B). For example, it can be the user (A) to initiate an intercom conversation with the non-compatible Bluetooth® device (B). It may also be the non-compatible Bluetooth® device (B) that initiates an intercom call with the user (A).

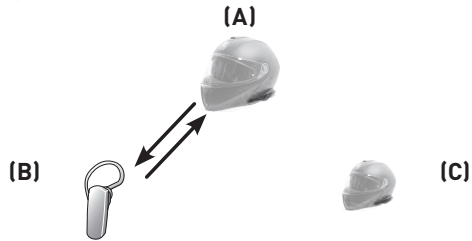

3. The other ARK (C) can join the intercom conversation by making an intercom call to the user's ARK (A).

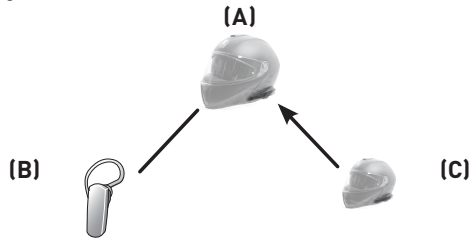

4. Now the user (A), the non-compatible Bluetooth® device (B) and the other ARK (C) are performing a three-way intercom conference.

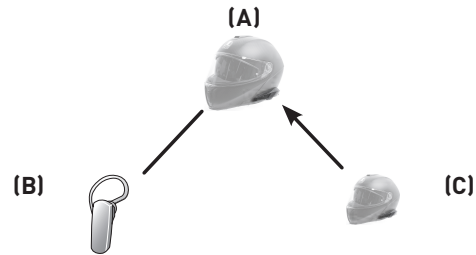

5. The user can disconnect from the Universal Intercom™ three-way conversation in the same way as for normal three-way intercom conversation. See paragraph 8.2.2, End three-way intercom.

11.4 FOUR-WAY UNIVERSAL INTERCOM™

You can make a four-way Universal Intercom™ connection with two different configurations:

- Two ARKs and two Bluetooth® devices not compatible: User's ARK (A); a non-compatible Bluetooth® device (B); another ARK (C); and a non-compatible Bluetooth® device (D).
- Three ARKs and an incompatible Bluetooth® device: User's ARK (A); one Bluetooth® device not compatible (B); two other ARKs (C and D).

The user can make the four-way Universal Intercom™ call the same way as a normal four-way intercom call.

11.4.1 Start four-way intercom - Case 1

Two non-compatible ARKs (A) and (C) and two Bluetooth® devices.

1. The user (A) can initiate an intercom conversation with the non-compatible Bluetooth® device (B).

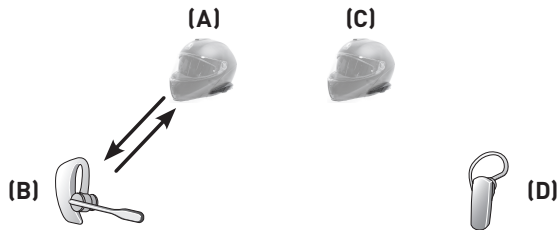

2. The other ARK (C) can join the intercom conversation by making an intercom call to the user (A).

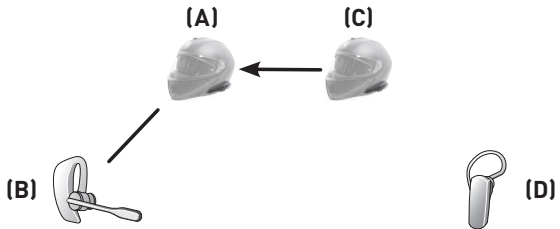

3. The non-compatible Bluetooth® device (D) can join the intercom conference by making an intercom call to ARK (C).

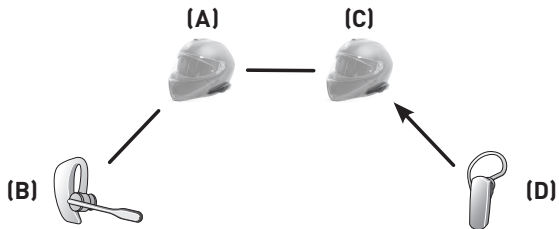

4. At this point, two ARKs (A and C) and two non-compatible Bluetooth® devices (B and D) are connected via four-way Universal Intercom™.

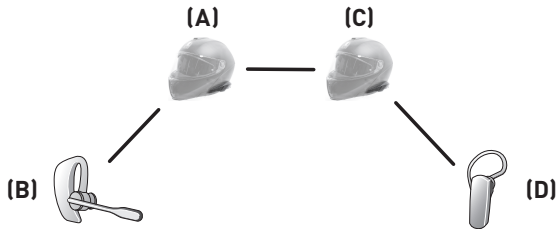

The user can disconnect from a four-way Universal Intercom™ in the same way as for a normal four-way Universal Intercom™ conversation. Refer to section 8.3.2, End four-way intercom.

11.4.2 Start four-way intercom - Case 2

Three ARKs (A), (C) and (D) and a non-compatible Bluetooth® device (B). The procedure is the same as described for Case 1 in section 11.4.1.

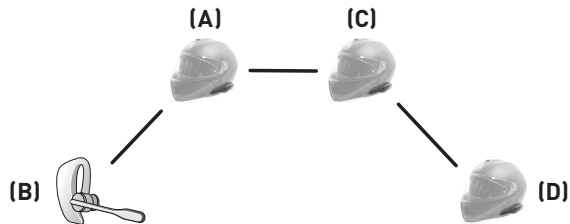

12 FM RADIO

12.1 SWITCHING ON AND OFF RADIO FM

To turn on the FM radio, press the [-] button for 1" until you hear a double average tone. Then, the voice prompt "FM on" and the frequency of the station being played back are emitted.

To turn off the FM radio, press the [-] button for 1" until the voice prompt "FM off" is heard.

When the power is turned off, ARK stores the station frequency and when the power is turned on, the latter station is played back.

Notice!

While listening to the FM radio, you can answer an incoming call and the intercom.

12.2 PRESET STATIONS

You can listen to music from preset stations while on FM radio, up to a maximum of 10. When the FM control is on, press the centre button for 1" to switch to the next stored preset station until the tenth is reached; a further press returns to the first stored station. Each time the preset station is changed, a voice prompt is emitted repeating the preset number ("One"; "Two"; "Three"; ...) followed by the frequency of the station being played back.

Notice!

If there are no 10 preset stations, switching between the two stations only follows the numbers for which there is a preset station. So if there is no preset station (if ARK is new or if a reset operation has been performed as described in paragraph 14.9), there is no switching to stations other than the one being played.

12.3 STATION SEARCH

This function allows you to search for stations with different frequencies. To use the Search function, follow the steps below:

1. Press the (+) or (-) button twice to search for stations forward or backward.
2. If the tuner finds a station while searching for frequencies, the Search function stops.

12.4 SAVING AND DELETING PRESET STATIONS

Once a station has been found using the search operation, it can be saved as a preset station (1 to 10):

1. To store the current station, press and hold the centre button for 3" until you hear the voice prompt "Preset (#)" followed by the preset number.
2. Press the (+) or (-) button to select the preset new station you want to assign to the station in question. The user can cancel the preprocessing operation by waiting for about 10". The voice prompt "Save preset cancelled" is then emitted.

3. To store the station, press the (+) button for 1". Then, the voice prompt "Save preset (#)" is emitted followed by the preset number.

If you want to delete one of the predefined stations, follow the same procedure using the (-) button at the end:

1. Press and hold the centre button for 3" until you hear the voice prompt "Preset *n*".
2. Press the (+) or (-) button to select the preset number you want to delete.
3. Press the (-) button for 1" to clear the station with the preset number. The voice prompt "Delete preset (#)" is emitted followed by the preset number.

 **Notice!**

After deleting a preset station, an empty position remains in the preset station sequence. To reactivate this position, a new station must be stored in place of the deleted station.

Preset FM stations can also be configured by connecting ARK to the PC and using the Sena™ Device Manager software. It allows you to save up to 10 FM preset station frequencies in the ARK settings menu. The same operation can be performed using the Sena™ Motorcycles application.

12.5 SCANNING AND SAVING

A scan is the function that automatically searches for station frequencies, starting from the current frequency at a glance. To use the Scan function, follow the steps below:

1. Press the (+) button for 1". The frequency of the station being played changes to search for frequencies from other stations.
2. If the tuner detects a station, it stays on that frequency for 8", after which it searches for the next station.
3. The search function stops when the (+) button is pressed again for 1".

4. To store a station during frequency analysis, press the center button when that station is playing back. The voice prompt "Save preset (#)" is emitted.
5. Even after saving a preset station, the scan continues until it is intentionally interrupted by pressing the (+) button for 1". Each further saving will take place with the next preset number (starting from 1 after 10).

 **Notice!**

All preset stations during scanning replace previously set stations.

12.6 PROVISIONAL PRESETTING

With the temporary preset function, you can automatically preset stations temporarily without changing existing preset stations.

Press the (+) button three times to automatically search for 10 preset stations. Pre-implement temporary stations are cancelled when the system is switched off.

12.7 FM SHARING

FM sharing allows you to listen to the radio during an intercom conversation.

To start FM sharing, press the (-) button for 1" during a two-way intercom conversation. During FM operation, you can switch to the next preset station either from the user's preset station sequence or from your intercom friend's preset station sequence, depending on who is making the change. The same applies to a search for a new frequency. In case one of the two frequency changes, the other one will listen to the same frequency.

To end FM sharing, press the (-) button for 1" or end the intercom call.



Notice!

FM sharing will stop if ARK starts a multivoice intercom conferencing.

When Audio Overlay™ is enabled, if you make an intercom call while listening to FM radio, FM sharing will not work.

12.8 AREA SELECTION

You can narrow the FM frequency band for the geographical area using the Sena™ Device Manager.

Area	Frequency radius	Phase
The whole world	76,0 ~ 108,0 MHz	± 100 kHz
Americas	87,5 ~ 107,9 MHz	± 200 kHz
Asia	87,5 ~ 108,0 MHz	± 100 kHz
Australia	87,5 ~ 107,9 MHz	± 200 kHz
Europe	87,5 ~ 108,0 MHz	± 100 kHz
Japan	76.0 ~ 95,0 MHz	± 100 kHz

13 PRIORITY FUNCTIONS

ARK works in the following order of priority:

highest priority

- Mobile phone / GPS
- Intercom / FM sharing
- Sharing music
via Bluetooth® stereo music
- Bluetooth® stereo music

lowest priority

- FM radio

A function with a lower priority will always be interrupted by a function with a higher priority. For example, stereo music is interrupted by an intercom call, and an intercom conversation is interrupted by an incoming call on the phone.



Notice!

If music is selected as the priority audio source (see 15.2), the order of priorities changes as follows:

highest priority

- Telephone / GPS
- Bluetooth® stereo music
- Intercom / FM sharing
- Sharing music
via Bluetooth® stereo music

lowest priority

- FM radio

14 ARK CONFIGURATION SETTINGS

ARK configuration can be done using the voice menu instructions, as described below.

1. To access the voice Configuration menu, press and hold the centre button for 10" until you hear a double high tone. The voice prompt "Configuration menu" is also emitted.
2. Press the (+) or (-) button to navigate through the menus. A voice prompt is an emitted for each menu item, as shown below.
3. You can perform the corresponding operation by pressing the center button.
4. If no button is pressed within 10", ARK abandons the configuration and returns to standby mode.

5. If you want to leave the configuration immediately, press the (+) or (-) button until the voice prompt "Exit Configuration" is heard, then press the centre button.

The voice prompts for each menu item are sorted below:

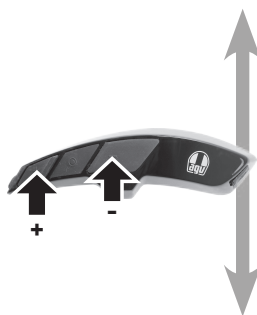

1. Phone pairing
2. Second mobile phone pairing
3. GPS pairing
4. Phone selective pairing
5. Media selective pairing
6. Delete all pairings
7. Remote Control pairing
8. Universal Intercom pairing
9. Factory reset
10. Exit configuration

14.1 PHONE PAIRING

To access the phone pairing mode, press the (+) or (-) button until the “Phone Pairing” voice prompt is heard. For details on pairing with mobile phones, see section 5.1.

By pressing the (+) or (-) button, you can exit the phone pairing mode.

14.2 SECOND MOBILE PHONE PAIRING

To access the second mobile phone pairing mode, press the (+) or (-) button until the voice prompt “Second mobile phone pairing” is heard. For further details, see section 5.2.

Pressing the (+) or (-) button will exit the second mobile phone pairing.

14.3 GPS PAIRING

To access GPS pairing mode, press the (+) or (-) button until the “GPS Pairing” voice prompt is emitted.

For detailed information on GPS pairing, see section 5.4, Pairing with GPS navigator.

Pressing the (+) or (-) button will exit the GPS pairing mode.

14.4 PHONE SELECTIVE PAIRING

To access the Phone selective pairing mode, press the (+) or (-) button until the “Phone selective pairing” voice prompt is heard.

For details on the phone selective pairing, refer to section 5.3.2, HFP call only.

Pressing the (+) or (-) button will exit the phone selective pairing mode.

14.5 MEDIA SELECTIVE PAIRING

To access the media selective pairing mode, press the (+) or (-) button until the “Media selective pairing” voice prompt is emitted.

For details on media selective pairing, refer to section 5.3.1, A2DP Stereo Music Only.

Pressing the (+) or (-) button exits the media selective pairing mode.

14.6 DELETE ALL PAIRINGS

To delete all ARK Bluetooth® pairing information, press the (+) or (-) button until you hear the voice prompt “Delete all pairing”, then press the center button to confirm.

14.7 REMOTE CONTROL PAIRING

To access Remote Pairing mode, press the (+) or (-) button until the “Remote control pairing” voice prompt is emitted.

Then press the centre button to access remote control pairing mode. ARK immediately abandons the configuration menu and pairs with the remote control (if the remote control is in pairing mode).

14.8 UNIVERSAL INTERCOM™ PAIRING

To access the Universal Intercom™ Pairing mode, press the (+) or (-) button until you hear the “Universal Intercom pairing” voice prompt.

Then press the centre button to access the Universal Intercom™ mode. ARK immediately abandons the configuration menu and performs Universal Intercom™ pairing (if the incompatible device is in pairing mode).

14.9 FACTORY RESET

To reset ARK to factory settings, press the (+) or (-) button until the "Factory reset" voice prompt is emitted, then press the centre button to confirm. ARK shuts down by sending a voice prompt "Headset reset, goodbye".

14.10 CONFIGURATION EXIT

To exit the voice menu Configuration and return to standby mode, press the (+) or (-) button until the "Exit Configuration" voice prompt is emitted, then press the centre button to confirm.

15 SOFTWARE CONFIGURATION SETTINGS

Ark configuration can also be carried out using the Device Manager or the Sena™ Motorcycles via the setup menus.

15.1 ASSIGNMENT OF THE SPEED DIAL

Set the speed dial numbers to make a speed dial call.

15.2 AUDIO SOURCE PRIORITY SETTING (DEFAULT SETTING: INTERCOM)

Audio Source Priority allows you to select the priority between intercom and music (which includes GPS application instructions and message notifications) from a smartphone.

If you select intercom as the priority audio source, the music will be interrupted during an intercom conversation.

If you select music as the priority audio source, intercom conversations will be interrupted while listening to music (see chapter 13).



The Audio Source Priority function is active only when Audio Overlay™ is disabled.

15.3 ENABLE/DISABLE THE AUDIO BOOST (DEFAULT SETTING: DISABLED)

Enabling the audio boost increases the overall maximum volume. Disabling the audio boost will decrease the overall maximum volume, but the sound is more balanced.

15.4 ENABLE/DISABLE THE SMART VOLUME CONTROL (DEFAULT SETTING: DISABLED)

The Smart Volume Control changes the volume level of the headset according to the ambient noise level. When disabled, the volume is controlled only manually. You can enable the level adjustment by setting the sensitivity to low, medium or high. The Smart Volume Control responds to ambient noise according to the selected sensitivity level.

15.5 ENABLE/DISABLE THE VOX PHONE (DEFAULT SETTING: ENABLE)

If this feature is enabled, you can answer incoming calls with your voice. During an incoming call, you can answer the phone by saying a word such as “Hello” out loud or blowing air into the microphone. VOX phone is temporarily disabled if you are connected to intercom. If this feature is disabled, you must press the center button to answer an incoming call (see 6.1).

15.6 ENABLE/DISABLE THE VOX INTERCOM (DEFAULT SETTING: DISABLED)

If this feature is enabled, you can voice start an intercom conversation with the last intercom friend you paired with. When you want to start an intercom connection, say a word out loud like “Hello” or blow air into the microphone. If you start an intercom conversation with voice, the intercom ends automatically when the user and his intercom friend remain silent for 20”. However, if you start an intercom conversation manually by pressing the center button, you must end the intercom conversation manually (see 8.1).



Notice!

However, if an intercom conversation with voice is initiated and ended manually by pressing the center button, it will not be possible to start the intercom conversation with voice temporarily. In this case, you need to press the center button to restart the intercom. In this way, ending an intercom conversation with the center button avoids repeated unintentional intercom connections due to strong wind noise. After restarting ARK, you can start the voice intercom again.

15.7 ENABLE/DISABLE HD VOICE (DEFAULT SETTING: DISABLED)

HD Voice allows you to communicate in high quality during phone calls. This feature increases the quality for clear and crisp sound during phone conversations. If enabled, intercom conversations are interrupted when an incoming phone call is received, and audio during intercom calls is excluded. If HD Voice is enabled, a three-way conference call with intercom participant is not available.



Make sure that the Bluetooth® device to be connected to ARK is HD Voice compatible.

15.8 ENABLE/DISABLE HD INTERCOM (DEFAULT SETTING: ENABLE)

HD Intercom improves the sound quality of a two voice intercom conversation from normal to HD. HD intercom is momentarily disabled when participating in a multivoice intercom conversation. If this feature is disabled, the sound quality of a two-way intercom conversation becomes normal.



HD intercom has a relatively shorter operating range than normal intercom.

HD intercom can only be used with Audio Overlay™ disabled.

15.9 SETTING OF VOX SENSITIVITY (DEFAULT SETTING: 3)

VOX sensitivity can be adjusted to suit your driving environment. Level 5 is the highest sensitivity setting and level 1 is the lowest.

15.10 ENABLE/DISABLE VOICE PROMPT (DEFAULT SETTING: ENABLE)

Voice prompts can be disabled via the software configuration stations, but the following voice prompts are always active.

- Voice prompts for headset configuration settings
- Voice prompts for the battery level indicator
- Voice prompts for speed dial
- Voice prompts for FM radio functions

15.11 ENABLE/DISABLE RDS AF SETTING (DEFAULT SETTING: DISABLED)

RDS AF Setting allows a receiver to automatically tune to an alternate frequency when a radio station signal becomes weak.

15.12 ENABLE/DISABLE FM STATION GUIDE (DEFAULT SETTING: ENABLED)

When FM station guide is enabled, FM station frequencies are provided via voice prompts when you select default stations. When FM station guide is disabled, voice prompts on FM station frequencies are not provided when selecting default stations.

15.13 ENABLE/DISABLE SIDETONE (DEFAULT SETTING: DISABLED)

Sidetone is an audio feedback of the user's voice. It is useful for speaking naturally at the appropriate level, depending on the change in helmet noise conditions. If this function is enabled, the user can hear what he or she is saying during an intercom conversation or a telephone call.

15.14 ENABLE/DISABLE ADVANCED NOISE CONTROL™ (DEFAULT SETTING: ENABLE)

When Advanced Noise Control™ is enabled, environmental noise on the voice during an intercom conversation is reduced. If the function is disabled, the ambient noise is mixed with the voice during the intercom conversation.



If you are using ARK with Bluetooth® Audio Pack for GoPro®, you can only enable or disable this feature during normal audio recording mode. In Ultra HD (UHD) Audio Mode this feature is automatically disabled.

15.15 ENABLE/DISABLE AUDIO OVERLAY™ (DEFAULT SETTING: DISABLED)

Audio Overlay™ allows you to listen to the audio of two features at the same time. When the Audio Overlay™ function is activated, the phone calls, GPS instructions and intercom conversations may overlap with the audio of the FM radio or music in the background, at a reduced volume.

Increasing or decreasing the volume of the foreground audio also increases or decreases the volume of the background overlaid audio.

The volume of the foreground audio can be adjusted via ARK. You can adjust the background audio level using the Sena™ Motorcycles application. When Audio Overlay™ is enabled, HD Intercom and Audio Source Priority are disabled.

Foreground*			Background**	
Telephone	GPS	Intercom	FM radio	Music / Smart Navigation
0 ^(A)	0 ^(A)			
	0	0		
		0 ^(B)	0	0 ^(B)
	0 ^(C)		0 ^(C)	0

* You can listen to two audio sources in the background at the same volume level at the same time.

** You can only listen to one audio in the background at a time while listening to one audio source in the foreground.

^(A) During calls, you can listen to GPS instructions and the volume level of both audio sources can be adjusted via headset.

^(B) During intercom conversations, GPS application instructions are played back in the background.

^(C) When you listen to GPS instructions, the FM radio is placed in the background.

Notice!

The Audio Overlay™ function is activated during two voice intercom conversations with an intercom device that supports this feature.

When the Audio Overlay™ function is disabled, the background source returns to the respective volume level.

On iOS devices, the use of the Audio Overlay™ function is limited.

For the correct functioning of the Audio Overlay™ function, it is necessary to switch on and off ARK.

Some GPS devices may not support this feature.

16 FIRMWARE UPDATE

ARK supports firmware updates. You can update the firmware using the Sena™ Device Manager (see section 4.7.1). To check the latest software available for download, go to <http://oem.sena.com/agv>.

17 TROUBLESHOOTING

17.1 RESET AFTER ERROR

When ARK is not working properly, you can try to restore operation by gently pressing the reset button in the hole on the back of the main unit. Insert a paper clip into the hole and press lightly for one second. ARK turns off. Restart the system and check for proper operation.

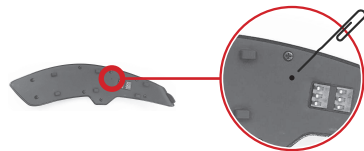

Notice!

To do this, you need to remove ARK from the carrier unit. The reset operation does not reset the headset to the factory settings.

17.2 FACTORY RESET

To restore ARK to factory settings, use the Reset function in Configuration. Headset automatically resets to factory settings and goes out.

For details, refer to section 14.9, “Factory Reset”.

18 QUICK REFERENCE

Type	Function	Button control	LED	Acoustic signal
Basic function	Switching on	Press the center button and the (+) button for 1"	Blue	Acoustic signals of increasing intensity
	Switching off	Press the center button and the (+) button	Red	Acoustic signals of decreasing intensity
	Adjusting the volume	Press the (+) button or the (-) button	-	-
	Silent microphone	Press the center button and the (-) button for 1"	-	Acoustic signals of decreasing/increasing intensity
Intercom	Intercom pairing	Press the center button for 5"	Flashing red	Single and double medium tone acoustic signal
		Press the center button of one of the two ARKs		

Type	Function	Button control	LED	Acoustic signal
Intercom	Starting / Stopping Each intercom conversion	Press the center button	-	-
	Interruption of all intercom conversations	Press the center button for 3"	-	-
	Start Group Intercom™	Press the (+) and (-) buttons simultaneously	Flashing green	-
	Stop Group Intercom™	Press the center button for 3"	-	-
Music	Playing/pausing Bluetooth® music	Press the center button for 1"	-	-
	Next / previous track	Press the (+) or (-) button for 1"		

Type	Function	Button control	LED	Acoustic signal
FM radio	Turning FM Radio on/off	Press the [-] button for 1"	-	Double medium tone beeps
	Preset selection	Press the center button for 1"	-	Single medium tone beep
	Station search	Press button [+] or button [-] twice	-	Triple high tone acoustic signal
	FM band analysis	Press the [+] button for 1"	-	-
	Stop analysis	Press the [+] button for 1"	-	Double high tone acoustic signal
	Preset saving during analysis	Press the center button	-	Double high tone acoustic signal

CERTIFICATION AND SAFETY APPROVALS

FCC COMPLIANCE STATEMENT

This device complies with part 15 of the FCC rules. Operation is subject to the following two conditions:

1. This device may not cause harmful interference, and
2. This device must accept any interference received, including interference that may cause undesired operation.

This equipment has been tested and found to comply with the limits for a Class B digital device pursuant to part 15 of the FCC rules.

These limits are designed to provide reasonable protection against harmful interference in a residential installation.

This equipment generates, uses and can radiate radio frequency energy and, if not installed and used in accordance with the instructions, may cause harmful interference to radio communications.

However, there is no guarantee that interference will not occur in a particular installation.

If this equipment does cause harmful interference to radio or television reception, which can be determined by turning the equipment on and off, the user is encouraged to try to correct the interference by one or more of the following measures:

- Reorient or relocate the receiving antennae.
- Increase the separation between the equipment and the receiver.
- Connect the equipment into an outlet on a circuit different from that to which the receiver is connected.
- Consult the dealer or an experienced radio/TV technician for help.

FCC RF EXPOSURE STATEMENT

This product is compliance to FCC RF Exposure requirements and refers to FCC website:

<https://apps.fcc.gov/oetcf/eas/reports/GenericSearch.cfm>
(search for FCC ID: S7A-SP66)

FCC CAUTION

Any changes or modifications to the equipment not expressly approved by the party responsible for compliance could void user's authority to operate the equipment.

CE DECLARATION OF CONFORMITY

This product is CE marked according to the provisions of the Radio Equipment Directive (2014/53/EU).

Hereby, Sena Technologies, Inc declares that the radio equipment type SP66 is in compliance with Directive 2014/53/EU.

For further information, please consult: oem.sena.com/agv/.

This device can be operated in at least one Member State without infringing applicable requirements on the use of radio spectrum.

Product: ARK

Model: SP66

RF Range for Bluetooth®: 2402 ~ 2480 MHz

Max Output Power(E.I.R.P.) for Bluetooth®: 17.41 dBm



INDUSTRY CANADA STATEMENT

This device complies with Industry Canada license-exempt RSS standard(s). Operation is subject to the following two conditions:

1. This device may not cause interference.
2. This device must accept any interference, including interference that may cause undesired operation of the device.

BLUETOOTH® LICENSE

The Bluetooth® word mark and logos are owned by the Bluetooth SIG, Inc. and any use of such marks by Sena Technologies, Inc is under license. Other trademarks and trade names are those of their respective owners.

The product is compliant with and adopts the Bluetooth® Specification 4.1 and has successfully passed all interoperability tests that are specified in the Bluetooth® specification.

However, interoperability between the device and other Bluetooth®-enabled products is not guaranteed.

WEEE (WASTE ELECTRICAL AND ELECTRONIC EQUIPMENT)

The crossed-out wheel bin symbol on the product, literature, or packaging reminds you that all electrical and electronic products, batteries, and accumulators must be taken to separate collection at the end of their working life.

This requirement applies to the European Union and other locations where separate collection systems are available.

To prevent possible harm to the environment or human health from uncontrolled waste disposal, please do not dispose of these products as unsorted municipal waste, but hand it in at an official collection point for recycling.



AFTER SALES SERVICES

TECHNICAL ASSISTANCE

Please contact an AGV Service Centre for any need of aftersales support.

To locate your nearest AGV Service Centre, consult the Stores section of the website www.agv.com.

To learn about mediation procedures, consult the FAQ section of the website www.agv.com, located on the navigation chart in the margin of the web page.

WARRANTY

Please contact an AGV Service Centre or consult the dedicated area on the website www.agv.com



Dainese S.p.A.

via Louvigny, 35
36064 Colceresa (VI), Italy
ph.: +39 0424 410711
www.agv.com

Dainese USA Inc.

1001 Brioso Drive
92627 Costa Mesa (CA), U.S.A.
ph.: +1 949 645 9500
www.agv.com

SENA

Sena Technologies, Inc.

19, Heolleung-ro 569-gil
Gangnam-gu Seoul, Republic of Korea
support.sena.com
www.sena.com

Sena Technologies, Inc.

152 Technology Drive
92618 Irvine (CA), U.S.A.
support.sena.com
www.sena.com